

Product information

Mini float switch

Series M60

Engler mini float switches are characterized by its compact and efficient design especially in the field of small vessel, system and aggregate monitoring.

The M60 series offers the user a wide range of standardized types regarding connection, fastening, material, functions as well as the possibility to assemble the mini float switch custom-made for is process.

Despite of attractive globally competitive prices Engler also offers in this segment first-class quality and a high level of service, flexibility and customer service.

Optionally it is possible to combine the level monitoring with temperature switches or temperature sensors and thus to reach an even better efficiency in the process of the user.

For more information please look at the following pages:

2. Mini float switch M60 with plug-type connector, 3-pole DIN 175301-803
Selection possibility regarding fastening, material, function and length
3. Mini float switch M60 with plug-type connector M12, 4-, 5-, 6- and 8-pole
Selection possibility regarding fastening, material, function and length
4. Mini float switch M60 with plug-type connector 2x M12
Selection possibility regarding fastening, material, function and length
5. Mini float switch M60 with terminal housing
Selection possibility regarding fastening, material, function and length
6. Mini float switch M60 with plug-type connector 6-pole DIN
Selection possibility regarding fastening, material, function and length
7. Mini float switch M60 out of stainless steel with M12 and 3-pole DIN plug-type connectors

Product information

Mini float switch M60 with plug-type connector 3-pole DIN



Order key

M60 . 1 . A1 . B4 . 100 . 200 . 01 . 01 . 8 . 600

Type mini float switch M60									
Material sliding tube brass tube ø8 --1 stainless steel tube ø8 --2									
Switching function point A 24V/150mA closes on level rise -- A1 opens on level rise -- A2 closes on level drop -- A3 opens on level drop -- A4									Optional Temperature switch: Technical details see page 16 60°C n. c. contact --- 600 65°C n. c. contact --- 650 70°C n. c. contact --- 700 75°C n. c. contact --- 750 85°C n. c. contact --- 850
Switching function point B 24VDC/150mA 230VAC/1A (with 1 switching point) function: closes on level rise -- B1 opens on level rise -- B2 closes on level drop -- B3 opens on level drop -- B4 Comment: For a device with only one switching point please use switching point B Example: M60.1.B4.100.01.01.8									Float ø17,8x32mm material NBR --- 8
Switching point SPA in mm according to customer's indication									
Switching point SPB in mm according to customer's indication									
Connection --- 01 3pole + PE DIN EN 175301-803									Mounting material Aluminium / PA6 screwed connection 1/2" --- 02 oval flange Lk55 ----- 23 screwed connection 3/4" ----- 13 round flange ø74 Lk60 ----- 46 screwed connection M20x1,5 -- 01 screwed connection 1" ----- 22 screwed connection M24x1,5 -- 33 screwed connection M22x1,5 -- 24

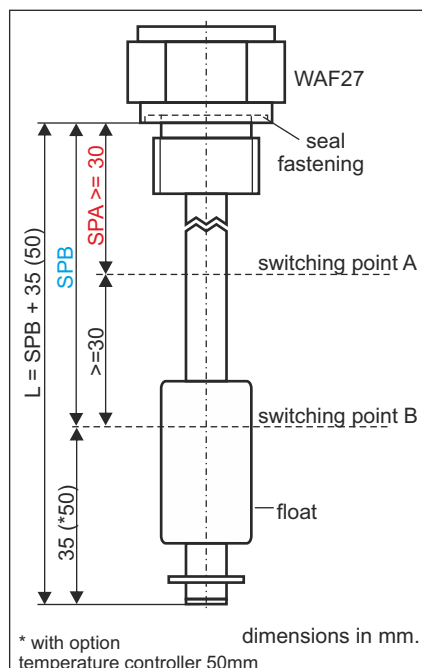

Product information

Mini float switch M60 with plug-type connector 2xM12



Order key

M60. 1 . A1 . B4 . 100 . 200 . 09 . 01 . 8 . 600

Type mini float switch M60

Material sliding tube
brass tube ø8 --1
stainless steel tube ø8 --2

Switching function point A 24V/150mA

closes on level rise -- A1
opens on level rise -- A2
closes on level drop -- A3
opens on level drop -- A4
change over contact -- A5

Switching function point B 24VDC/150mA

closes on level rise -- B1
opens on level rise -- B2
closes on level drop -- B3
opens on level drop -- B4
change over contact -- B5

Comment:
For a device with only one
switching point please use
switching point B
Example: M60.1.B4.100.01.01.8

Switching point SPA
in mm according to customer's indication

Switching point SPB
in mm according to customer's indication

Connection
 2x M12 4 pole --- 09

Optional

Temperature switch:
Technical details see page 16
60°C n. c. contact --- 60O
65°C n. c. contact --- 65O
70°C n. c. contact --- 70O
75°C n. c. contact --- 75O
85°C n. c. contact --- 85O







Temperature sensor PT100
Technical details see page 16
PT100 2 wire --- PT100
PT100 3 wire --- PT103
PT100 4 wire --- PT104

Temperature sensor PT1000
Technical details see page 16
PT1000 2 wire --- PT1000

Float

 ø17,8x32mm Material NBR --- 8

Mounting material Aluminium / PA6

-  screwed connection 1/2" ----- 02
-  screwed connection 3/4" ----- 13
-  screwed connection 1" ----- 22
-  round flange
ø74 Lk60 ----- 46
-  screwed connection M20x1,5 --- 01
-  screwed connection M22x1,5 --- 24
-  screwed connection M24x1,5 --- 33

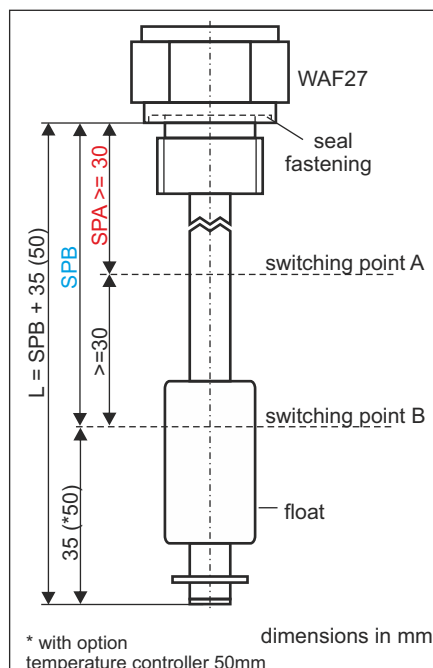

Product information

Mini float switch M60 with terminal housing



Order key

M60. 1 . A1 . B4 . 100 . 200 . 10 . 01 . 8 . 600

Type mini float switch M60

Material sliding tube
brass tube ø8 --1
stainless steel tube ø8 --2

Switching function point A 24V/150mA
closes on level rise -- A1
opens on level rise -- A2
closes on level drop -- A3
opens on level drop -- A4
change over contact -- A5

Switching function point B 230VAC/1A (1 switching point)
24VDC/150mA (2 switching point)

closes on level rise -- B1
opens on level rise -- B2
closes on level drop -- B3
opens on level drop -- B4
change over contact -- B5
Comment:
For a device with only one
switching point please use
switching point B
Example: M60.1.B4.100.01.01.8

Switching point SPA
in mm according to customer's indication

Switching point SPB
in mm according to customer's indication

connection --- 10

terminal housing
material aluminium

Optional

Temperature switch:
Technical details see page 16
60°C n. c. contact --- 600
65°C n. c. contact --- 650
70°C n. c. contact --- 700
75°C n. c. contact --- 750
85°C n. c. contact --- 850

Temperature sensor PT100
Technical details see page 16
PT100 2 wire --- PT100
PT100 3 wire --- PT103
PT100 4 wire --- PT104

Temperature sensor PT1000
Technical details see page 16
PT1000 2 wire --- PT1000

Float

ø17,8x32mm material NBR --- 8

Mounting material aluminium / PA6

- screwed connection 1/2" ----- 02
- oval flange Lk55 ----- 23
- screwed connection 3/4" ----- 13
- round flange
ø74 LK60 ----- 46
- screwed connection M20x1,5 --- 01
- screwed connection 1" ----- 22
- screwed connection M24x1,5 --- 33
- screwed connection M22x1,5 --- 24

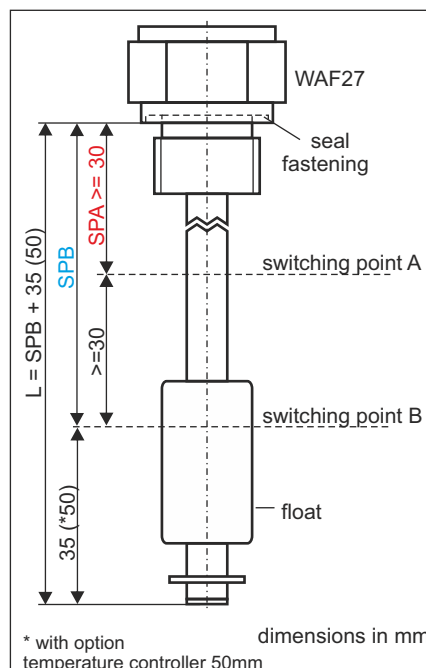

Product information

Mini float switch M60 with plug-type connector 6-pole DIN



Order key

M60 . 1 . A1 . B4 . 100 . 200 . 13 . 01 . 8 . 600

Type mini float switch M60

Material sliding tube
brass tube ø8 --1
stainless steel tube ø8 --2

Switig function point A 24V/150mA
closes on level rise -- A1
opens on level rise -- A2
closes on level drop -- A3
opens on level drop -- A4
change over contact -- A5

Switching function point B 230VAC/1A (1 switching point)
24VDC/150mA (2 switching points)

closes on level rise -- B1
opens on level rise -- B2
closes on level drop -- B3
opens on level drop -- B4
change over contact -- B5

Comment:
For a device with only one
switching point please use
switching point B
Example: M60.1.B4.100.01.01.8

Switching point SPA
in mm according to customer's indication

Switching point SPB
in mm according to customer's indication

Connection

6pole + PE nach
DIN EN 175201-804
(DIN 43651)-- 13

Optional

Temperature switch:
Technical details see page 16
60°C n. c. contact --- 600
65°C n. c. contact --- 650
70°C n. c. contact --- 700
75°C n. c. contact --- 750
85°C n. c. contact --- 850

Temperature sensor PT100
Technical details see page 16
PT100 2 wire --- PT100
PT100 3 wire --- PT103
PT100 4 wire --- PT104

Temperature sensor PT1000
Technical details see page 16
PT1000 2 wire --- PT1000

Float

ø17,8x32mm material NBR --- 8

Mounting material aluminium

screwed connection M20x1,5 --- 01
 screwed connection 1" ----- 22

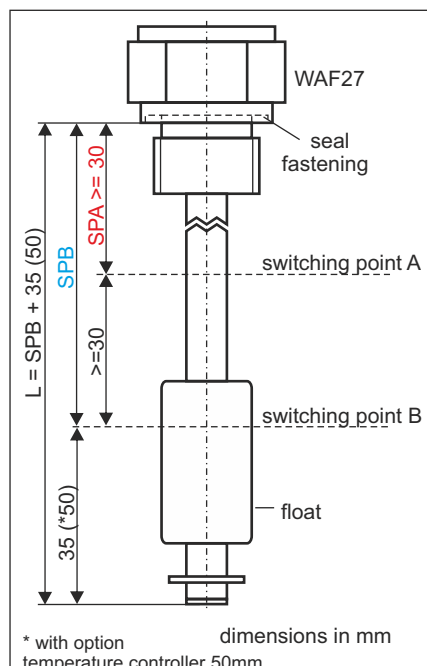

Product information

Mini float switch M60 out of stainless steel with M12 or 3-pole DIN plug-type connector



Order key

M60 . 2 . A1 . B4 . 100 . 200 . 02 . 10 . 2 . 600

Type mini float switch M60

Material sliding tube
stainless steel tube $\varnothing 8$ --2

Switching function point A 24V/150mA

closes on level rise -- A1
opens on level rise -- A2
closes on level drop -- A3
opens on level drop -- A4

Switching function point B 230VAC/1A (1 switching point and only in combination with connection 01)
24VDC/150mA (2 switching point)

closes on level rise -- B1
opens on level rise -- B2
closes on level drop -- B3
opens on level drop -- B4

Comment:
For a device with only one switching point please use switching point B
Example: M60.2.B4.100.01.10.2

Switching point SPA
in mm according to customer's indication

Switching point SPB
in mm according to customer's indication

Connection

M12 4 pole --- 02
M12 5 pole --- 08
M12 6 pole --- 17
M12 8 pole --- 12

3pol + PE DIN EN 175301-803 --- 01

Optional

Temperature switch:
Technical details see page 16
60°C n. c. contact --- 600
65°C n. c. contact --- 650
70°C n. c. contact --- 700
75°C n. c. contact --- 750
85°C n. c. contact --- 850

Temperature sensor PT100
Technical details see page 16
PT100 2 wire --- PT100
PT100 3 wire --- PT103
PT100 4 wire --- PT104

Temperature sensor PT1000
Technical details see page 16
PT1000 2 wire --- PT1000

Comment: Sensors only possible in conjunction with M12 plug-type connector

Float

$\varnothing 27 \times 31$ mm
material stainless steel --- 2
only in combination with 1" screwed connection

$\varnothing 17,8 \times 32$ mm material NBR --- 8

Mounting material stainless steel

screwed connection 1" ----- 10
in connection with M12 WAF27

screwed connection 1" ----- 10
in connection with DIN 3 pole WAF40

screwed connection 1/2" ----- 27
only with NBR float type 52

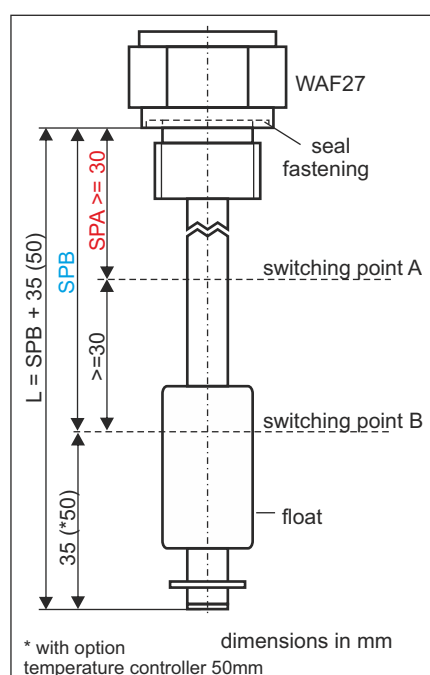

Data sheet / product information

Mini float switch M60...01.02.8

plug-type connector 3-pole DIN EN 175301-803

Mounting 1/2"

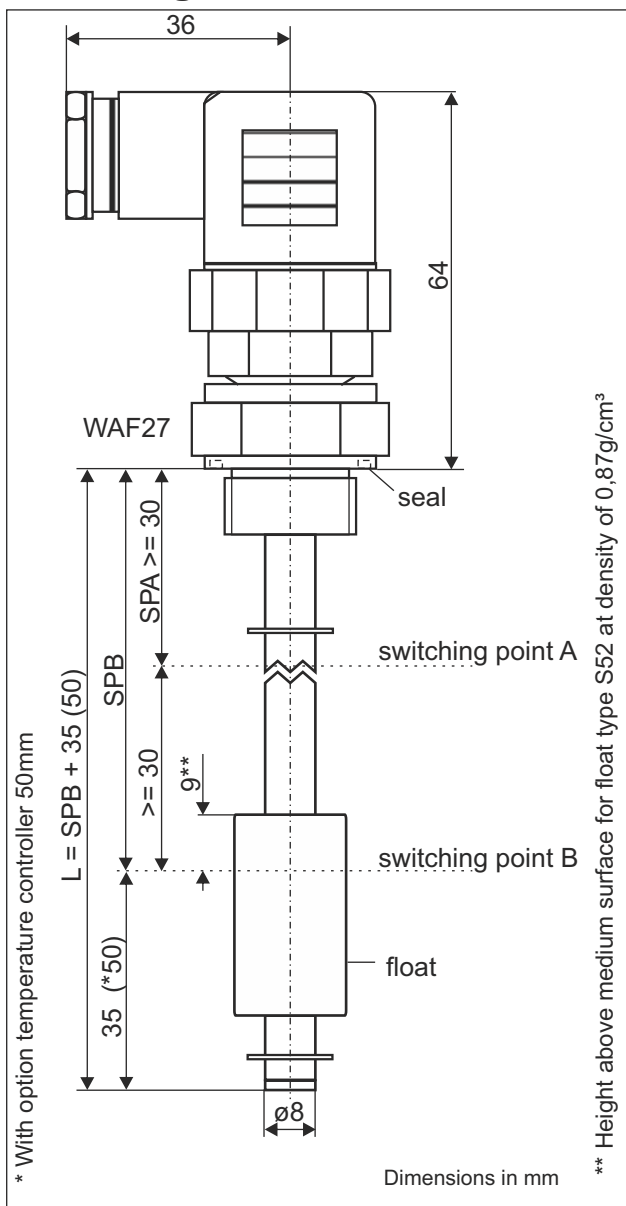

Terminal diagrams 3-pole + PE DIN EN 175301-803

(further connection alternatives upon requests)

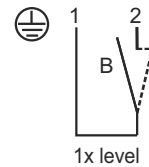

1x level

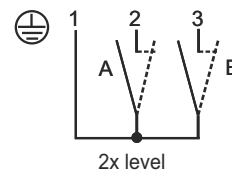

2x level

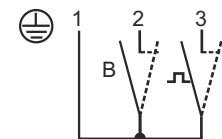

1x level, 1x temperature switch

Comment: Contacts possible either as n.o. contact or n.c. contact

[Back to product group](#)

Technical data:

Connection:	3 pole + PE connector according DIN EN 175301-803 (DIN 43650), material PA
Mounting:	thread 1/2", material aluminium
Mounting position:	vertical $\pm 10^\circ$
Seal:	profile seal, material NBR
Sliding tube:	$\varnothing 8$ mm material brass or stainless steel, length and material according to customer specification
Float:	$\varnothing 17,8 \times 32$ mm, material NBR, type S52
Reed contact:	max. 2x reed contacts n.o. contacts / n.c. contacts, function bistable
Switching voltage:	max. 230VAC for one switching point; for two switching point max. 24VDC
Switching current:	1A for one switching point; for two switching points 150mA
Temperature switching:	optional, power rating see page 16
Temperature sensor:	optional, power rating see page 16
Pressure:	max. 1 bar
Operating temperature:	-20°C to 100°C in medium, -15°C to 70°C above mounting
Protection rating:	IP 65

Hotline +49 (0)7389 90920 - eMail info@engler-msr.de

Data sheet / product information

Mini float switch M60...01.23.8

plug-type connector 3-pole DIN EN 175301-803

Mounting oval flange

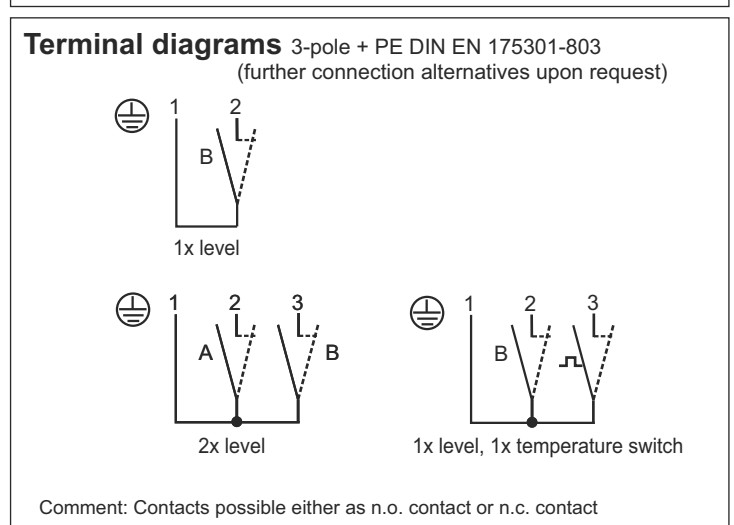
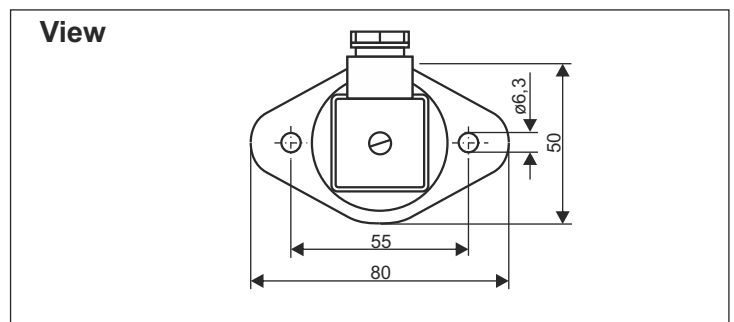
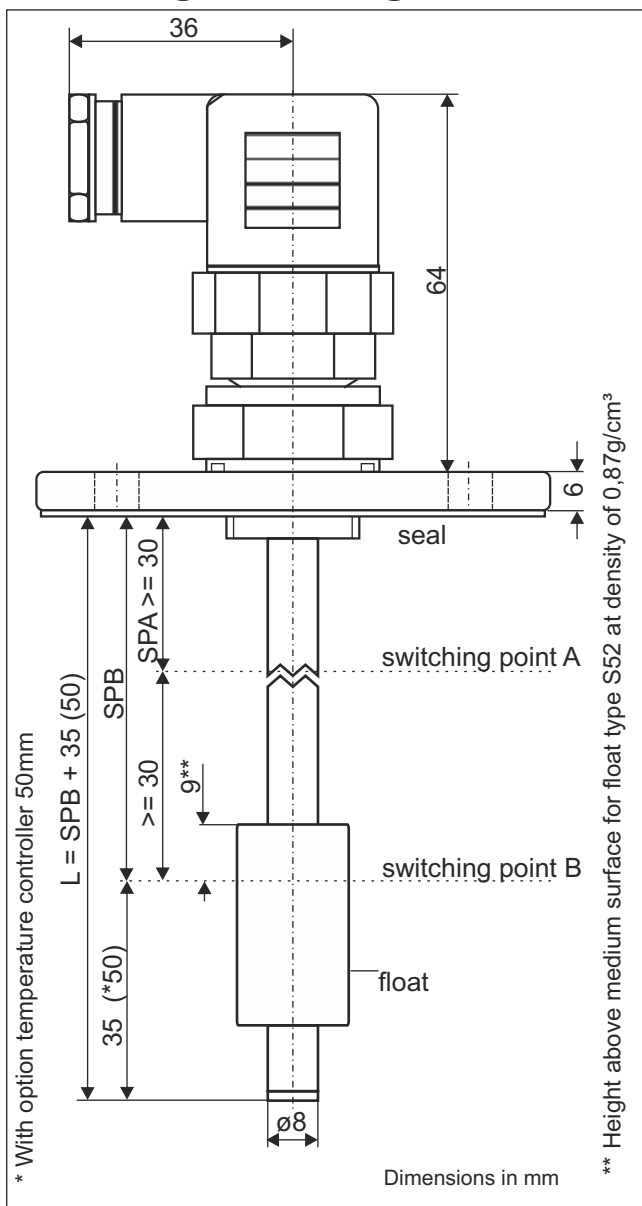

[Back to product group](#)

Technical data:

Connection:	3 pole + PE connector according DIN EN 175301-803 (DIN 43650), material PA
Mounting:	oval flange, LK 55mm, material makrolon
Mounting position:	vertical $\pm 10^\circ$
Seal:	flat seal, material NBR
Sliding tube:	$\varnothing 8$ mm material brass or stainless steel, length and material according to customer specification
Float:	$\varnothing 17,8 \times 32$ mm, material NBR, type S52
Reed contact:	max. 2x reed contacts n.o. contacts / n.c. contacts, function bistable
Switching voltage:	max. 230VAC for one switching point; for two switching points max. 24VDC
Switching current:	1A for one switching point; for two switching points 150mA
Temperature switching:	optional, power rating see page 16
Temperature sensor:	optional, power rating see page 16
Pressure:	max. 1 bar
Operating temperature:	-20°C to 100°C in medium, -15°C to 70°C above mounting
Protection rating:	IP 65

Hotline +49 (0)7389 90920 - eMail info@engler-msr.de

Data sheet / product information

Mini float switch M60...01.13.8

plug-type connector 3pole DIN EN 175301-803

Mounting 3/4"

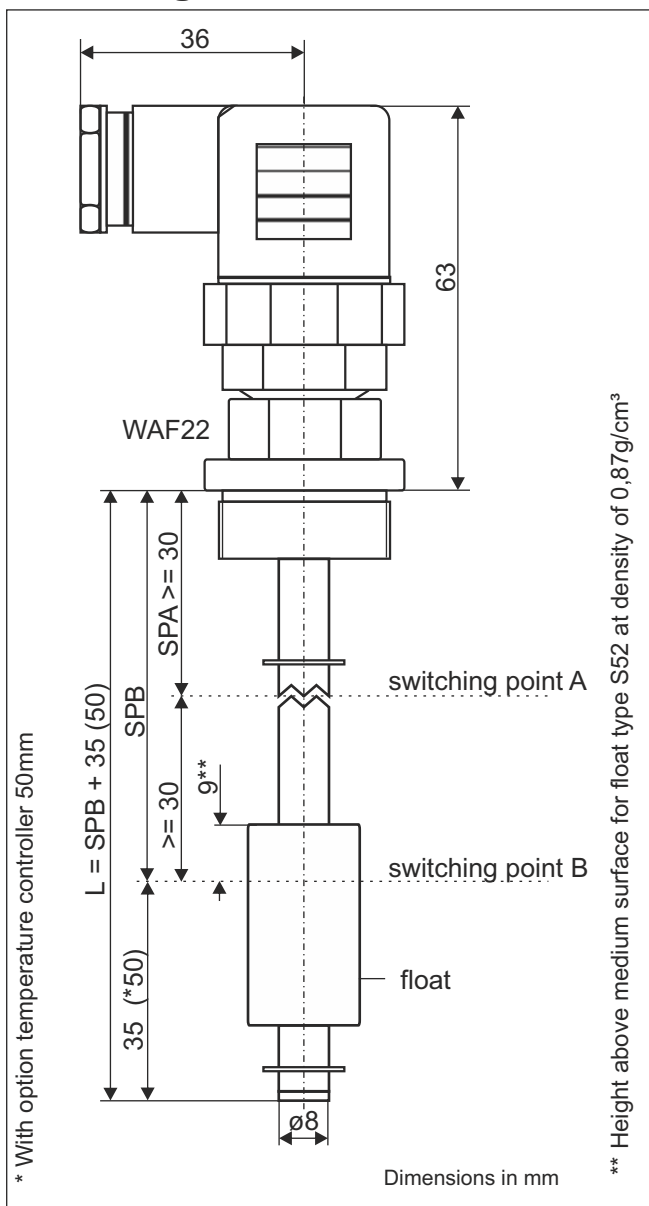

Terminal diagrams 3-pole + PE DIN EN 175301-803

(further connection alternatives upon request)

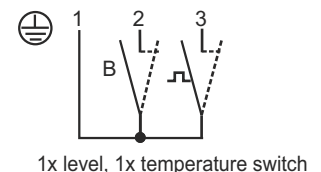
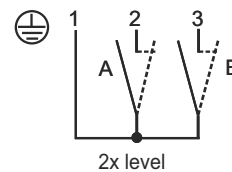
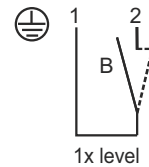

Comment: Contacts possible either as n.o. contact or n.c. contact

[Back to product group](#)

Technical data:

Connection:	3 pole + PE connector according DIN EN 175301-803 (DIN 43650), material PA
Mounting:	thread 3/4", material aluminium
Mounting position:	vertical $\pm 10^\circ$
Sliding tube:	$\varnothing 8$ mm material brass or stainless steel, length and material according to customer specification
Float:	$\varnothing 17,8 \times 32$ mm, material NBR, type S52
Reed contact:	max. 2x reed contacts n.o. contacts / n.c. contacts, function bistable
Switching voltage:	max. 230VAC for one switching point; for two switching points max. 24VDC
Switching current:	1A for one switching point; for two switching points 150mA
Temperature switching:	optional, power rating see page 16
Temperature sensor:	optional, power rating see page 16
Pressure:	max. 1 bar
Operating temperature:	-20°C to 100°C in medium, -15°C to 70°C above mounting
Protection rating:	IP 65

Data sheet / product information

Mini float switch M60...01.01.8

plug-type connector 3-pole DIN EN 175301-803

Mounting M20x1,5

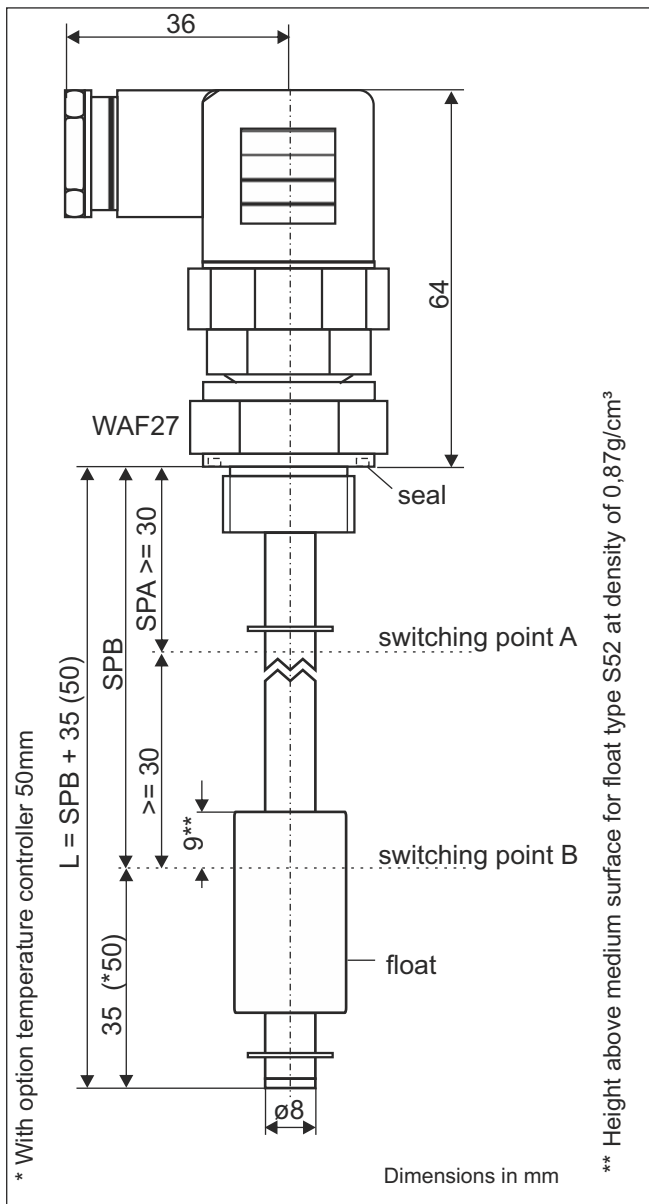

Terminal diagrams 3-pole + PE DIN EN 175301-803

(further connection alternatives upon request)

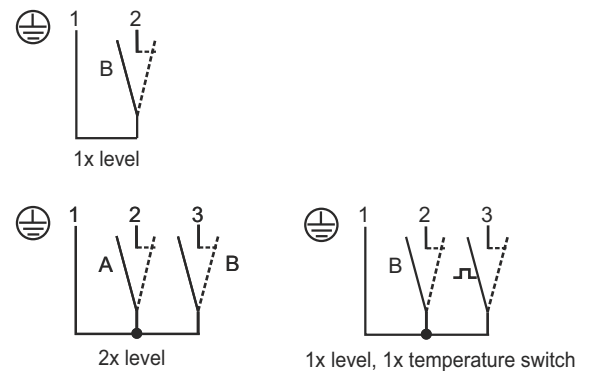

Comment: Contacts possible either as n.o. contact or n.c. contact

[Back to product group](#)

Technical data:

Connection:	3 pole + PE connector according DIN EN 175301-803 (DIN 43650), material PA
Mounting:	thread M20x1,5mm, material aluminium
Mounting position:	vertical $\pm 10^\circ$
Seal:	profile seal, material NBR
Sliding tube:	$\varnothing 8$ mm material brass or stainless steel, length and material according to customer specification
Float:	$\varnothing 17,8 \times 32$ mm, material NBR, type S52
Reed contact:	max. 2x reed contacts n.o. contacts / n.c. contacts, function bistable
Switching voltage:	max. 230VAC for one switching point; for two switching points max. 24VDC
Switching current:	1A for one switching point; for two switching points 150mA
Temperature switching:	optional, power rating see page 16
Temperature sensor:	optional, power rating see page 16
Pressure:	max. 1 bar
Operating temperature:	-20°C to 100°C in medium, -15°C to 70°C above mounting
Protection rating:	IP 65

Hotline +49 (0)7389 90920 - eMail info@engler-msr.de

Data sheet / product information

Mini float switch M60...01.46.8

plug-type connector 3-pole DIN EN 175301-803

Mounting round flange

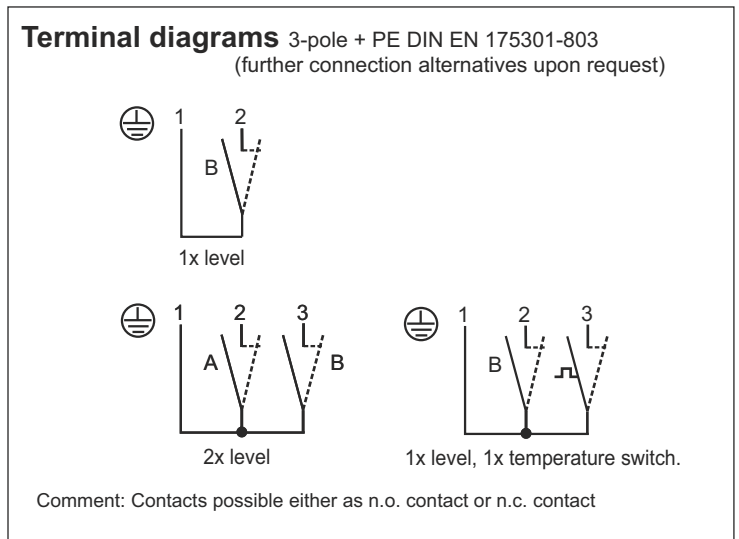
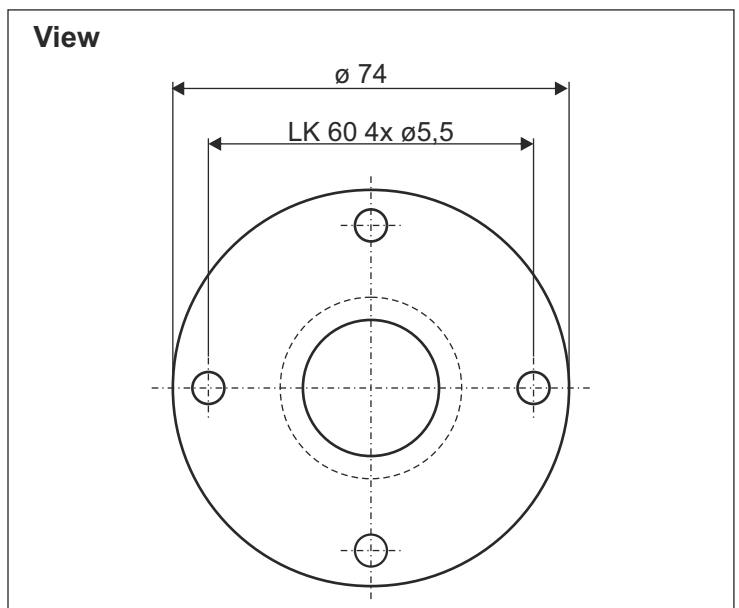
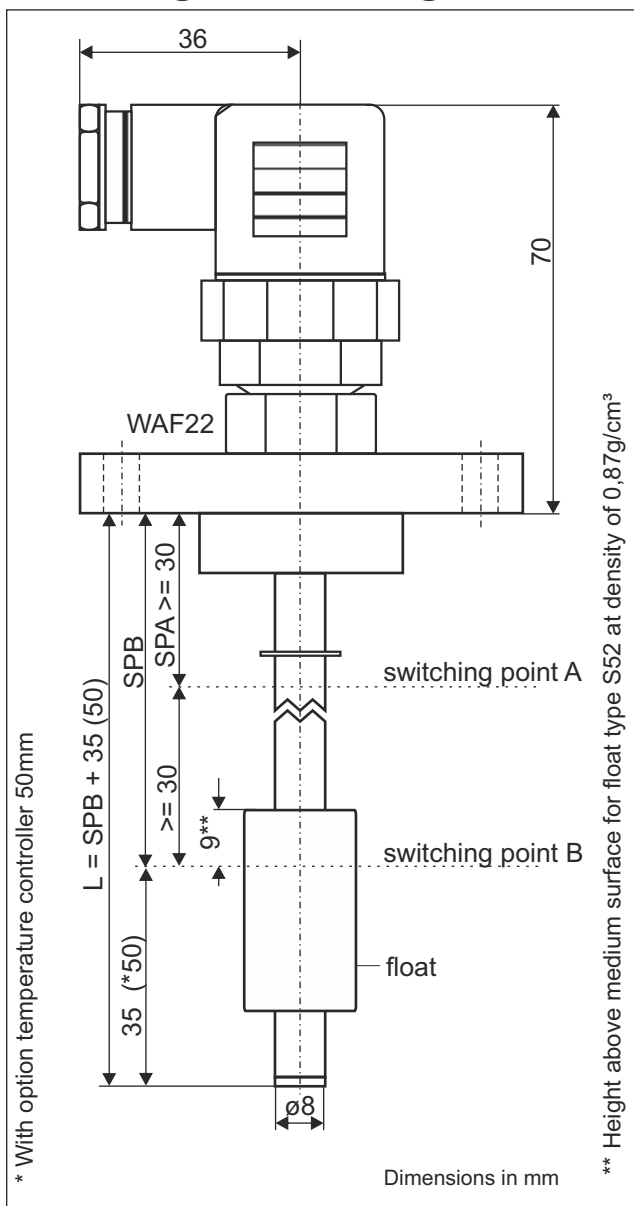

[Back to product group](#)

Technical data:

Connection:	3 pole + PE connector according DIN EN 175301-803 (DIN 43650), material PA
Mounting:	round flange AD 74mm, LK 60mm, material aluminium
Mounting position:	vertical $\pm 10^\circ$
Sliding tube:	$\varnothing 8$ mm material brass or stainless steel, length and material according to customer specification
Float:	$\varnothing 17,8 \times 32$ mm, material NBR, type S52
Reed contact:	max. 2x reed contacts n.o. contacts / n.c. contacts, function bistable
Switching voltage:	max. 230VAC for one switching point; for two switching points max. 24VDC
Switching current:	1A for one switching point; for two switching points 150mA
Temperature switching:	optional, power rating see page 16
Temperature sensor:	optional, power rating see page 16
Pressure:	max. 1 bar
Operating temperature:	-20°C to 100°C in medium, -15°C to 70°C above mounting
Protection rating:	IP 65

Data sheet / product information

Mini float switch M60...01.22.8

plug-type connector 3-pole DIN EN 175301-803

Mounting 1"

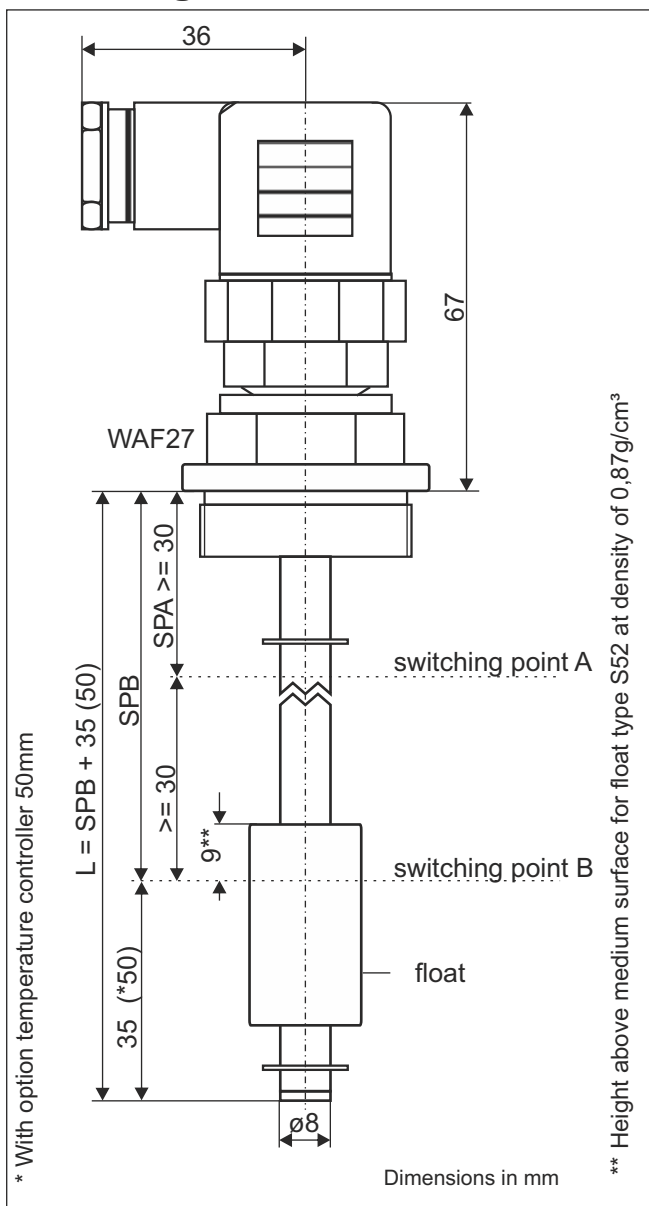

Terminal diagrams 3-pole + PE DIN EN 175301-803

(further connection alternatives upon requests)

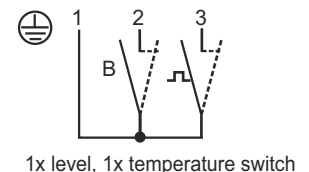
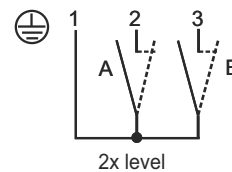
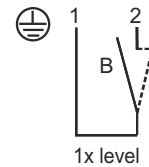

Comment: Contacts possible either as n.o. contact or n.c. contact

[Back to product group](#)

Technical data:

Connection:	3 pole + PE connector according DIN EN 175301-803 (DIN 43650), material PA
Mounting:	thread 1", material aluminium
Mounting position:	vertical $\pm 10^\circ$
Sliding tube:	$\varnothing 8$ mm material brass or stainless steel, length and material according to customer specification
Float:	$\varnothing 17,8 \times 32$ mm, material NBR, type S52
Reed contact:	max. 2x reed contacts n.o. contacts / n.c. contacts, function bistable
Switching voltage:	max. 230VAC for one switching point; for two switching points max. 24VDC
Switching current:	1A for one switching point; for two switching points 150mA
Temperature switching:	optional, power rating see page 16
Temperature sensor:	optional, power rating see page 16
Pressure:	max. 1 bar
Operating temperature:	-20°C to 100°C in medium, -15°C to 70°C above mounting
Protection rating:	IP 65

Data sheet / product information

Mini float switch M60...01.33.8

plug-type connector 3-pole DIN EN 175301-803

Mounting M24x1,5

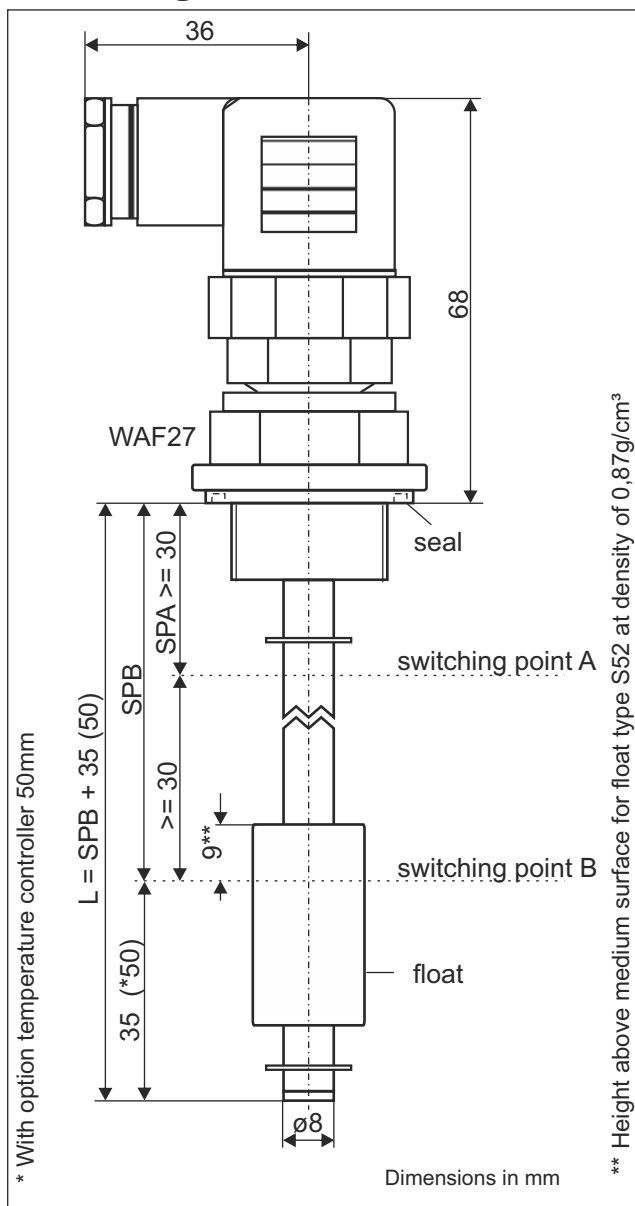

Terminal diagrams 3-pole + PE DIN EN 175301-803

(further connection alternatives upon request)

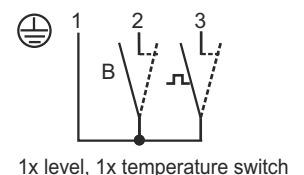
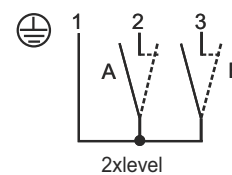
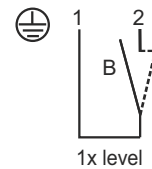

Comment: Contacts possible either as n.o. contact or n.c. contact

[Back to product group](#)

Technical data:

Connection:	3 pole + PE connector according DIN EN 175301-803 (DIN 43650), material PA
Mounting:	thread M24x1,5mm, material aluminium
Mounting position:	vertical $\pm 10^\circ$
Seal:	O-ring $\varnothing 26 \times 2$, material NBR
Sliding tube:	$\varnothing 8$ mm material brass or stainless steel, length and material according to customer specification
Float:	$\varnothing 17,8 \times 32$ mm, material NBR, type S52
Reed contact:	max. 2x reed contacts n.o. contacts / n.c. contacts, function bistable
Switching voltage:	max. 230VAC for one switching point; for two switching points max. 24VDC
Switching current:	1A for one switching point; for two switching points 150mA
Temperature switching:	optional, power rating see page 16
Temperature sensor:	optional, power rating see page 16
Pressure:	max. 1 bar
Operating temperature:	-20°C to 100°C in medium, -15°C to 70°C above mounting
Protection rating:	IP 65

Hotline +49 (0)7389 90920 - eMail info@engler-msr.de

Data sheet / product information

Mini float switch M60...01.24.8

plug-type 3-pole DIN EN 175301-803

Mounting M22x1,5

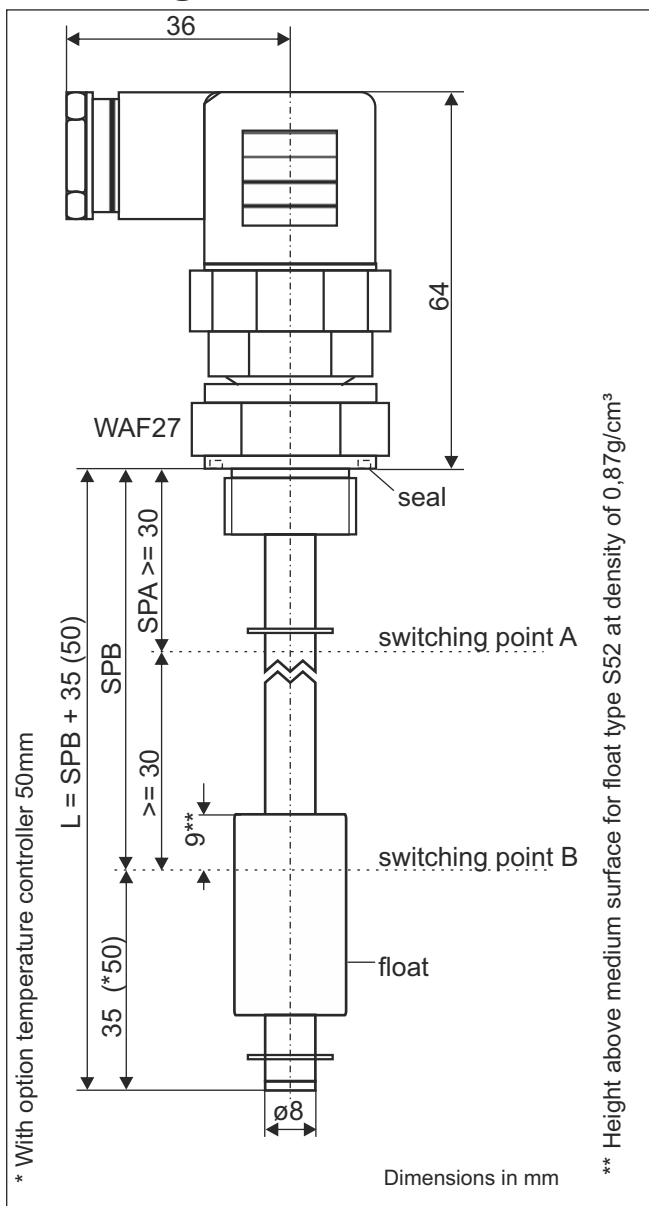

Terminal diagrams 3-pole + PE DIN EN 175301-803

(further connection alternatives upon request)

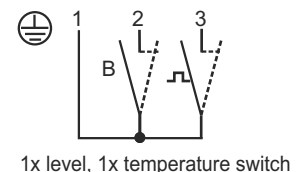
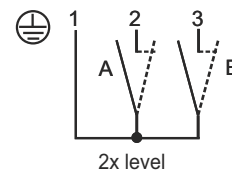
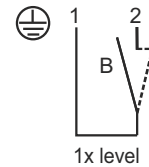

Comment: Contacts possible either as n.o. contact or n.c. contact

[Back to product group](#)

Technical data:

Connection:	3 pole + PE connector according DIN EN 175301-803 (DIN 43650), material PA
Mounting:	thread M22x1,5mm, material aluminium
Mounting position:	vertical $\pm 10^\circ$
Seal:	profile seal, material NBR
Sliding tube:	$\varnothing 8$ mm material brass or stainless steel, length and material according to customer specification
Float:	$\varnothing 17,8 \times 32$ mm, material NBR, type S52
Reed contact:	max. 2x reed contacts n.o. contacts / n.c. contacts, function bistable
Switching voltage:	max. 230VAC for one switching point; for two switching points max. 24VDC
Switching current:	1A for one switching point; for two switching points 150mA
Temperature switching:	optional, power rating see page 16
Temperature sensor:	optional, power rating see page 16
Pressure:	max. 1 bar
Operating temperature:	-20°C to 100°C in medium, -15°C to 70°C above mounting
Protection rating:	IP 65

Hotline +49 (0)7389 90920 - eMail info@engler-msr.de

Data sheet / Product information

Temperature switch, PT100 and PT1000 optional to mini float switch series M60

Temperature switch:

Temperature switch point ranges:

Switching temperature	Reset temperature	Switching temperature	Reset temperature
40°C±5K	≥ 27°C	95°C±5K	70°C±15K
45°C±5K	≥ 30°C	100°C±5K	70°C±15K
50°C±5K	≥ 33°C	105°C±5K	75°C±15K
55°C±5K	34-47°C	110°C±5K	75°C±15K
60°C±5K	35-52°C	115°C±5K	80°C±15K
65°C±5K	36-57°C	120°C±5K	85°C±15K
70°C±5K	38-60°C	125°C±5K	90°C±15K
75°C±5K	38-63°C	130°C±5K	95°C±15K
80°C±5K	55°C±15K	135°C±5K	100°C±15K
85°C±5K	60°C±15K	140°C±5K	105°C±15K
90°C±5K	65°C±15K	145°C±5K	105°C±15K

Technical data:

Technology: bimetal

Accuracy: ±5K

Switching voltage: 230VAC - connection 01, 10, 13
24VDC - connection 02, 08, 09, 12, 17

Switching current: 1A - connection 01, 10, 13
150mA - connection 02, 08, 09, 12, 17

Temperature sensor PT100

PT100 2 wire --- PT100

PT100 3 wire --- PT103

PT100 4 wire --- PT104

Technical data:

Nominal resistance: 100 Ohm at 0°C

Tolerance: DIN EN 60751, class B

Temperature coefficient: TK = 3850ppm/K

Temperature range: -20 up to 100°C

Self-heating: 0,4K/mW

Temperature sensor PT1000

PT1000 2 wire --- PT1000

PT1000 3 wire --- PT1003

Technical data:

Nominal resistance: 1000 Ohm at 0°C

Tolerance: DIN EN 60751, class B

Temperature coefficient: TK = 3850ppm/K

Temperature range: -20 up to 100°C

Self-heating: 0,2K/mW

Data sheet / product information

Mini float switch M60...02.02.8 / M60...08.02.8

plug-type connector M12 4-pole / 5-pole

Mounting 1/2"

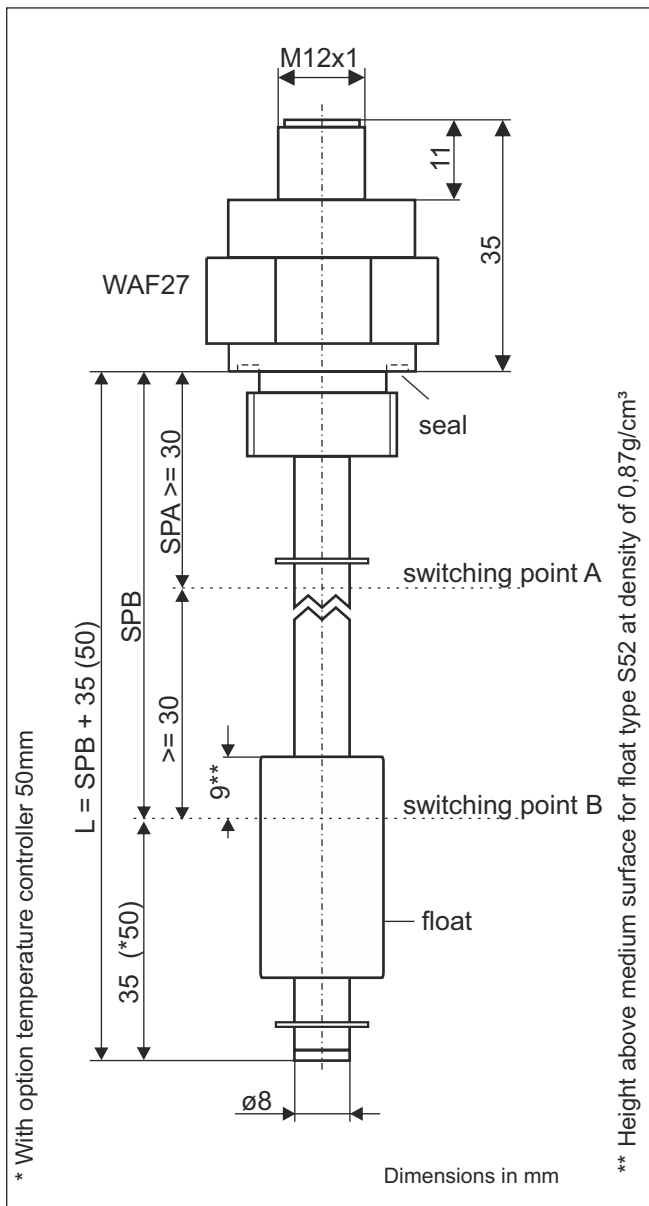

Terminal diagrams

M12 4-pole (02)

Comment: Contacts possible either as n.o. contact or n.c. contact

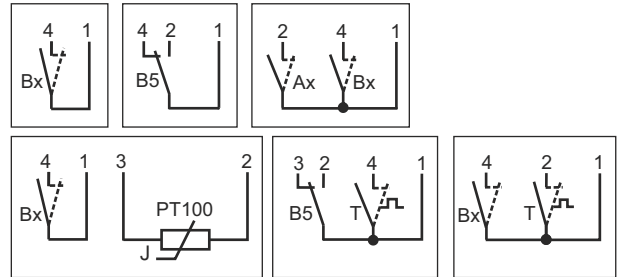

M12 5-pole (08)

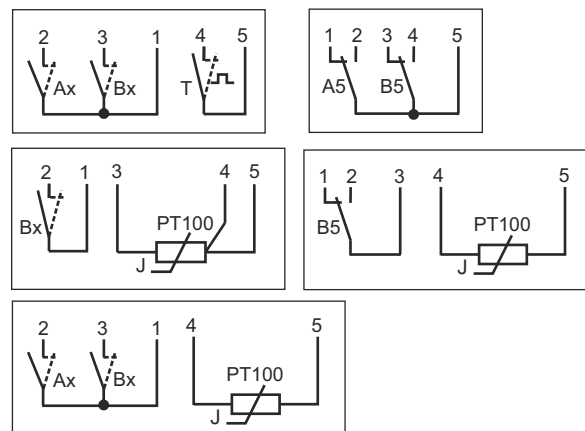

[Back to product group](#)

Technical data:

Connection:	plug-type connector M12x1, 4-pole and 5-pole, material TPU
Mounting:	thread 1/2", material aluminium
Mounting position:	vertical $\pm 10^\circ$
Seal:	profile seal, material NBR
Sliding tube:	$\varnothing 8$ mm material brass or stainless steel, length and material according to customer specification
Float:	$\varnothing 17,8 \times 32$ mm, material NBR, type S52
Reed contact:	max. 2x reed contacts n.o. contacts / n.c. contacts or 2x change over contact, function bistable
Switching voltage:	max. 24VDC
Switching current:	150mA
Temperature switching:	optional, power rating see page 16
Temperature sensor:	optional, power rating see page 16
Pressure:	max. 1 bar
Operating temperature:	-20°C to 100°C in medium, -15°C to 70°C above mounting
Protection rating:	IP 65

Data sheet / product information

Mini float switch M60...02.23.8 / M60...08.23.8

plug-type connector M12 4-pole / 5-pole

Mounting oval flange

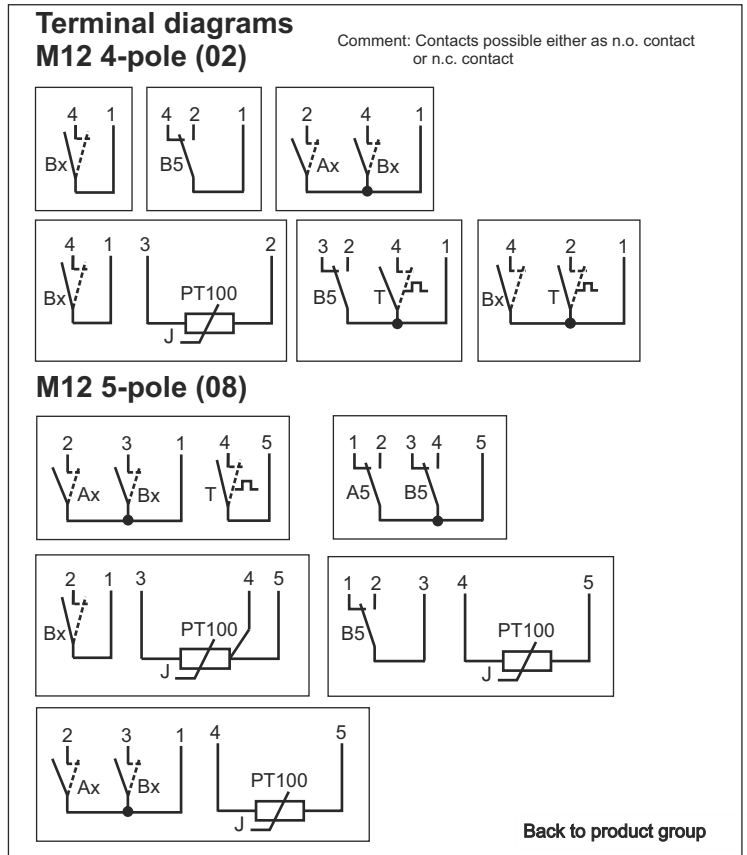
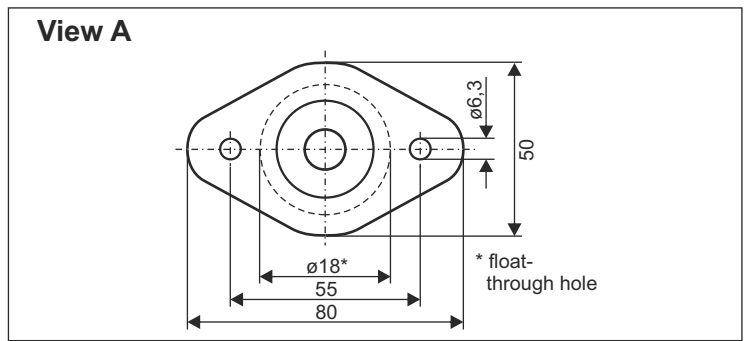
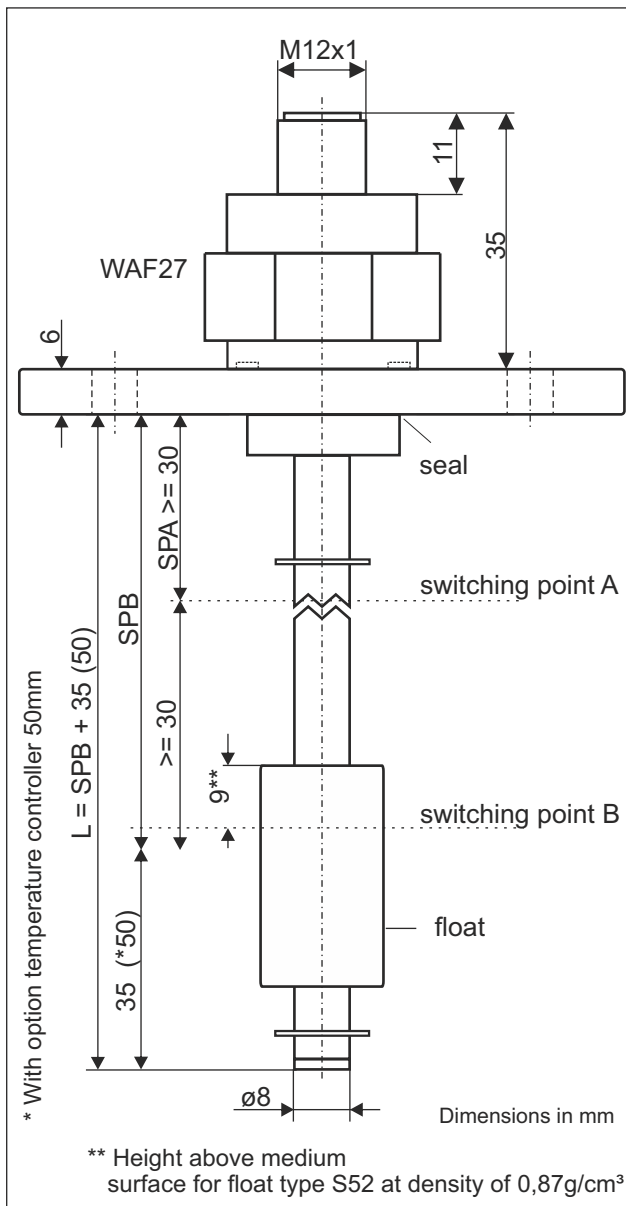

Technical data:

Connection:	plug-type connector M12x1, 4-pole and 5-pole, material TPU
Mounting:	oval flange 80x50mm, material makrolon
Mounting position:	vertical $\pm 10^\circ$
Seal:	material NBR
Sliding tube:	$\varnothing 8$ mm material brass or stainless steel, length and material according to customer specification
Float:	$\varnothing 17,8 \times 32$ mm, material NBR, type S52
Reed contact:	max. 2x reed contacts n.o. contacts / n.c. contacts or 2x change over contact, function bistable
Switching voltage:	max. 24VDC
Switching current:	150mA
Temperature switching:	optional, power rating see page 16
Temperature sensor:	optional, power rating see page 16
Pressure:	max. 1 bar
Operating temperature:	-20°C to 100°C in medium, -15°C to 70°C above mounting
Protection rating:	IP 65

Data sheet / product information

Mini float switch M60...02.13.8 / M60...08.13.8

plug-type connector M12 4-pole / 5-pole

Mounting 3/4"

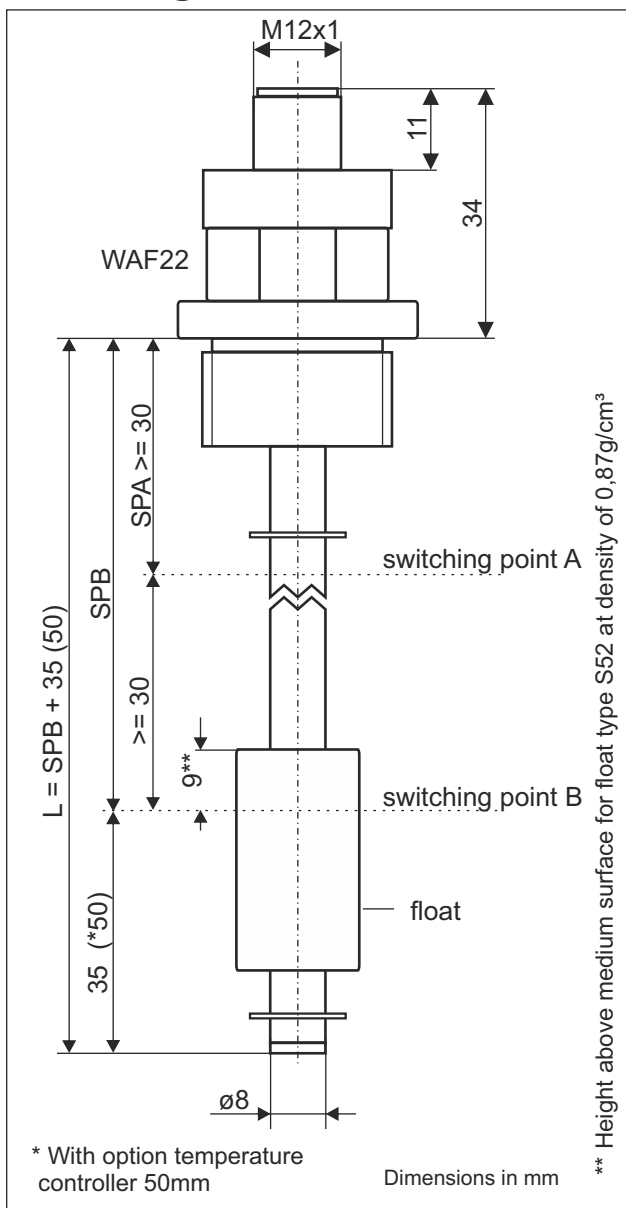

Terminal diagrams

M12 4-pole (02)

Comment: Contacts possible either as n.o. contact or n.c. contact

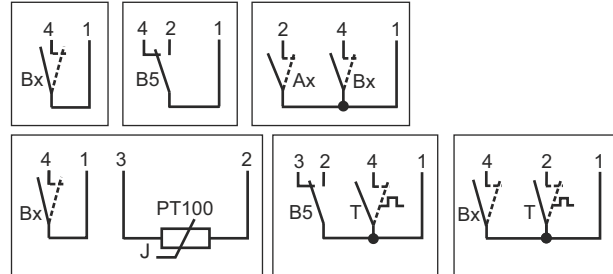

M12 5-pole (08)

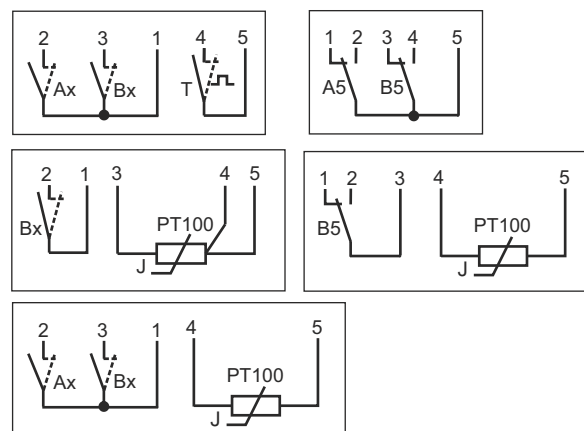

[Back to product group](#)

Technical data:

Connection:	plug-type connector M12x1, 4-pole and 5-pole, material TPU
Mounting:	thread 3/4", material aluminium
Mounting position:	vertical ± 10°
Sliding tube:	ø8mm material brass or stainless steel, length and material according to customer specification
Float:	ø17,8x32mm, material NBR, type S52
Reed contact:	max. 2x reed contacts n.o. contacts / n.c. contactc or 2x change over contact, function bistable
Switching voltage:	max. 24VDC
Switching current:	150mA
Temperature switching:	optional, power rating see page 16
Temperature sensor:	optional, power rating see page 16
Pressure:	max. 1 bar
Operating temperature:	-20°C to 100°C in medium, -15°C to 70°C above mounting
Protection rating:	IP 65

Hotline +49 (0)7389 90920 - eMail info@engler-msr.de

TS14 - 11.01.2021 - be - G: je, ph -TS_EKat_M60_Typenfamilie.cdr

Data sheet / product information

Mini float switch M60...02.01.8 / M60...08.01.8

plug-type connector M12 4-pole / 5-pole

Mounting M20x1,5

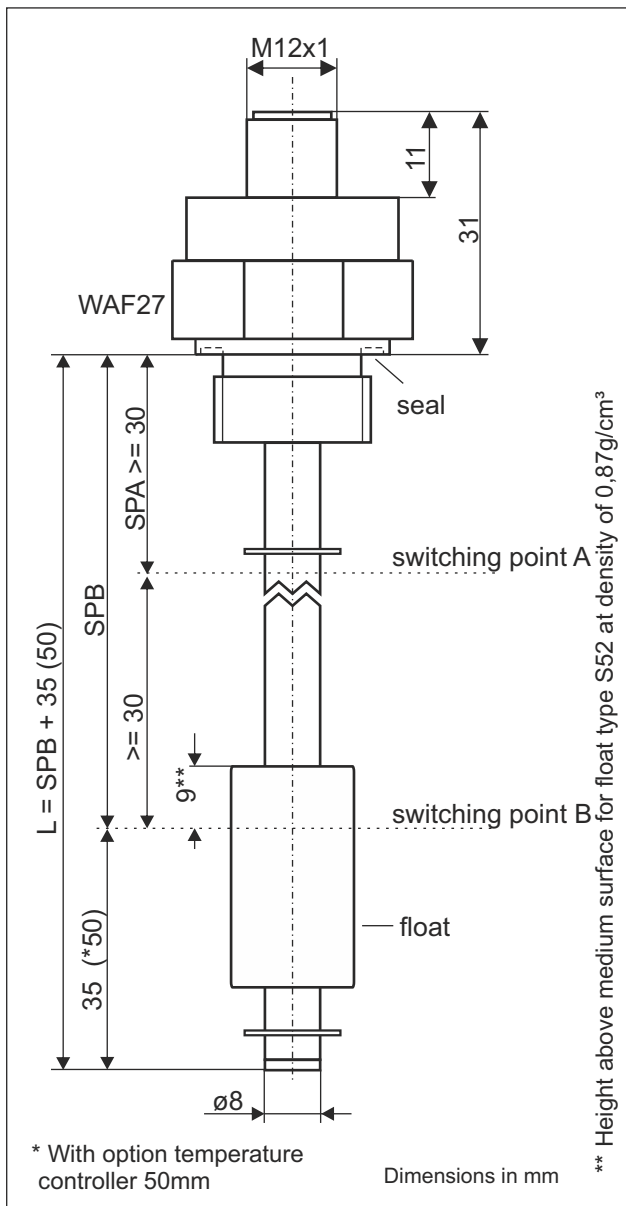

Terminal diagrams

M12 4pole (02)

Comment: Contacts possible either as n.o. contact or n.c. contact

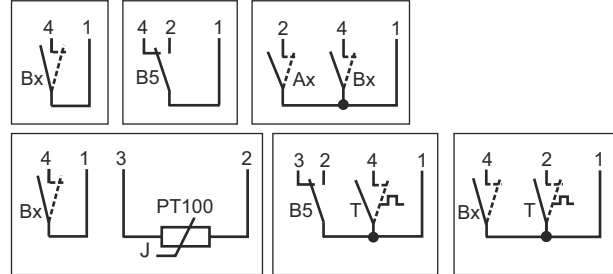

M12 5-pole (08)

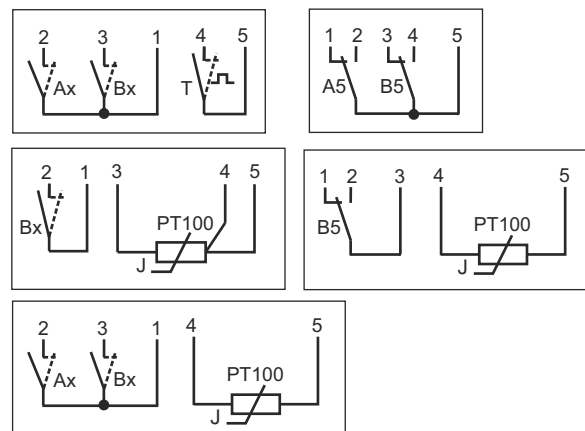

[Back to product group](#)

Technical data:

Connection:	plug-type connector M12x1, 4-pole and 5-pole, material TPU
Mounting:	thread M20x1,5mm, material aluminium
Mounting position:	vertical $\pm 10^\circ$
Seal:	profile seal, material NBR
Sliding tube:	$\varnothing 8$ mm material brass or stainless steel, length and material according to customer specification
Float:	$\varnothing 17,8 \times 32$ mm, material NBR, type S52
Reed contact:	max. 2x reed contacts n.o. contact / n.c. Contact or 2x change over contact, function bistable
Switching voltage:	max. 24VDC
Switching current:	150mA
Temperature switching:	optional, power rating see page 16
Temperature sensor:	optional, power rating see page 16
Pressure:	max. 1 bar
Operating temperature:	-20°C to 100°C in medium, -15°C to 70°C above mounting
Protection rating:	IP 65

Data sheet / product information

Mini float switch M60...02.22.8 / M60...08.22.8

plug-type connector M12 4-pole / 5-pole

Mounting 1"

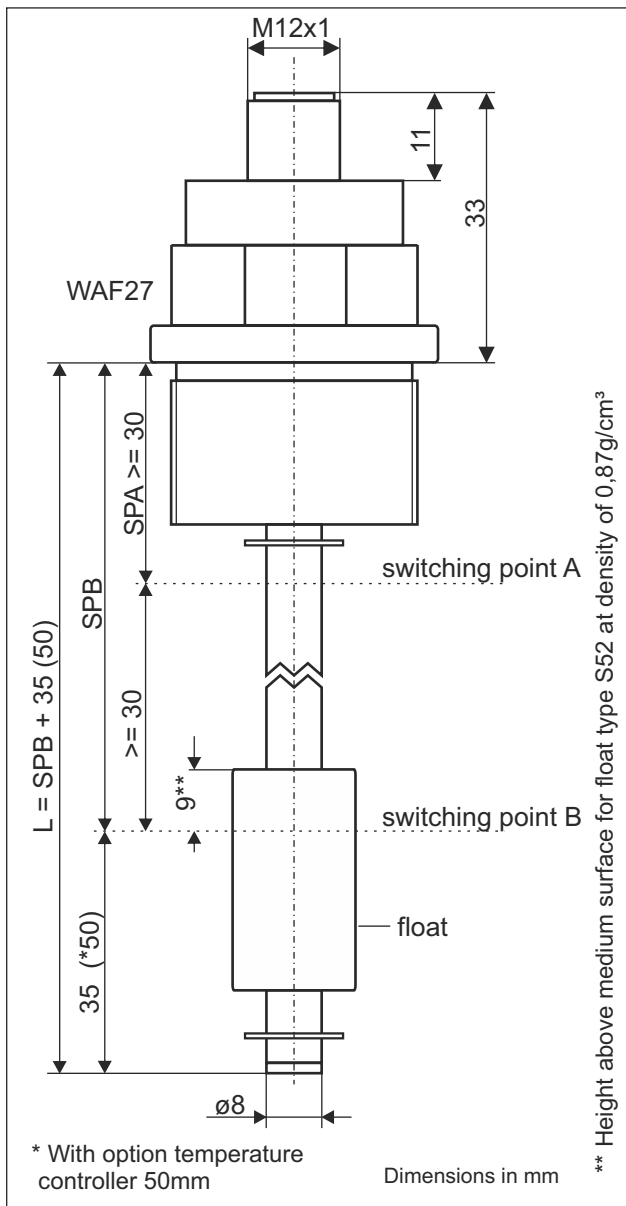

Terminal diagrams

M12 4-pole (02)

Comment: Contacts possible either as n.o. contact or n.c. contact

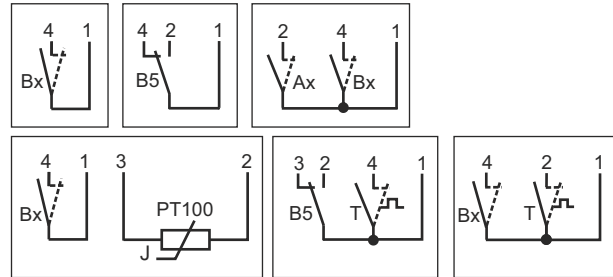

M12 5-pole (08)

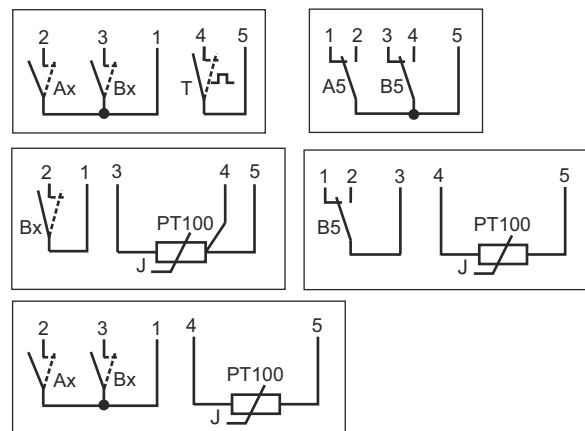

[Back to product group](#)

Technical data:

Connection:	plug-type connector M12x1 4-pole and 5-pole, material TPU
Mounting:	thread 1", material aluminium
Mounting position:	vertical $\pm 10^\circ$
Sliding tube:	$\varnothing 8$ mm material brass or stainless steel, length and material according to customer specification
Float:	$\varnothing 17,8 \times 32$ mm, material NBR, type S52
Reed contact:	max. 2x reed contacts n.o., contact/ n.c. contact or 2x change over contact, function bistable
Switching voltage:	max. 24VDC
Switching current:	150mA
Temperature switching:	optional, power rating see page 16
Temperature sensor:	optional, power rating see page 16
Pressure:	max. 1 bar
Operating temperature:	-20°C to 100°C in medium, -15°C to 70°C above mounting
Protection rating:	IP 65

Data sheet / product information

Mini float switch M60...02.33.8 / M60...08.33.8

plug-type connector M12 4-pole / 5-pole

Mounting M24x1,5

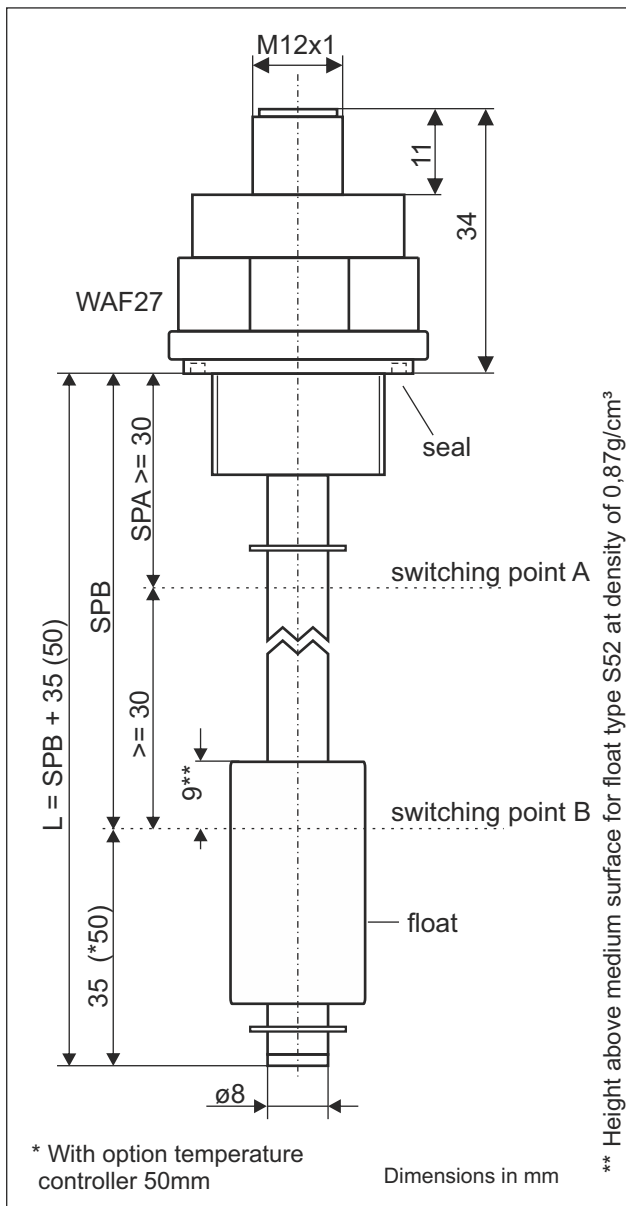

Terminal diagrams

M12 4-pole (02)

Comment: Contacts possible either as n.o. contact or n.c. contact

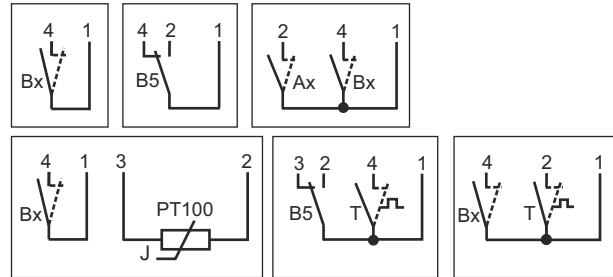

M12 5-pole (08)

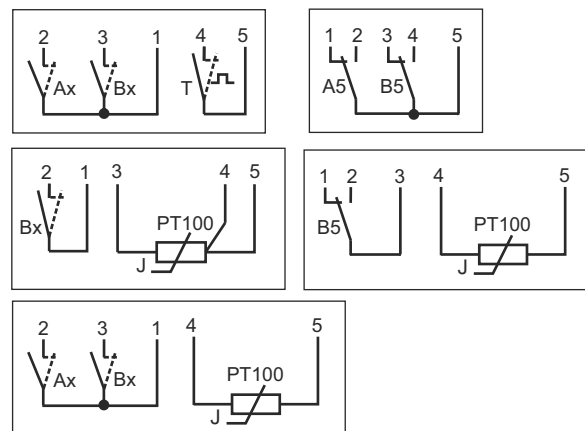

[Back to product group](#)

Technical data:

Connection:	plug-type connector M12x1, 4-pole and 5-pole, material TPU
Mounting:	thread M24x1,5mm, material aluminium
Mounting position:	vertical $\pm 10^\circ$
Seal:	profile seal, material NBR
Sliding tube:	$\varnothing 8$ mm material brass or stainless steel, length and material according to customer specification
Float:	$\varnothing 17,8 \times 32$ mm, material NBR, type S52
Reed contact:	max. 2x reed contact n.o., contacts/ n.c. Contact or 2x change over contact, function bistable
Switching voltage:	max. 24VDC
Switching current:	150mA
Temperature switching:	optional, power rating see page 16
Temperature sensor:	optional, power rating see page 16
Pressure:	max. 1 bar
Operating temperature:	-20°C to 100°C in medium, -15°C to 70°C above mounting
Protection rating:	IP 65

Data sheet / product information

Mini float switch M60...09.02.8

with plug-type connector 2xM12

Mounting 1/2"

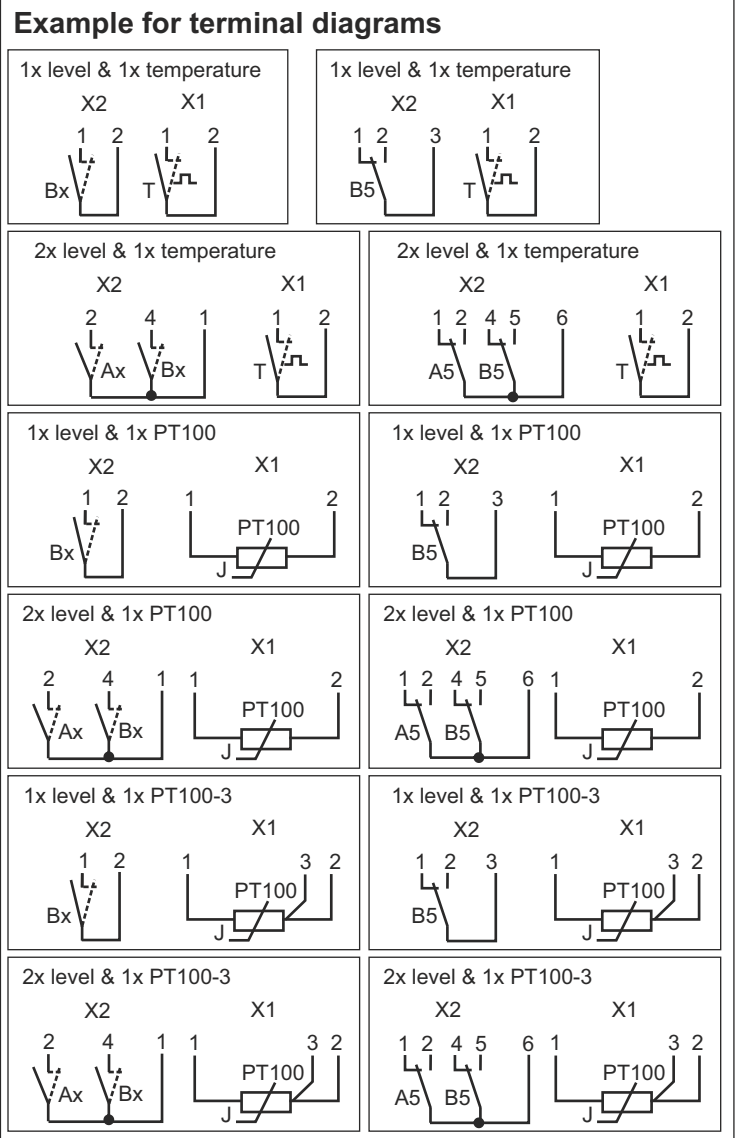
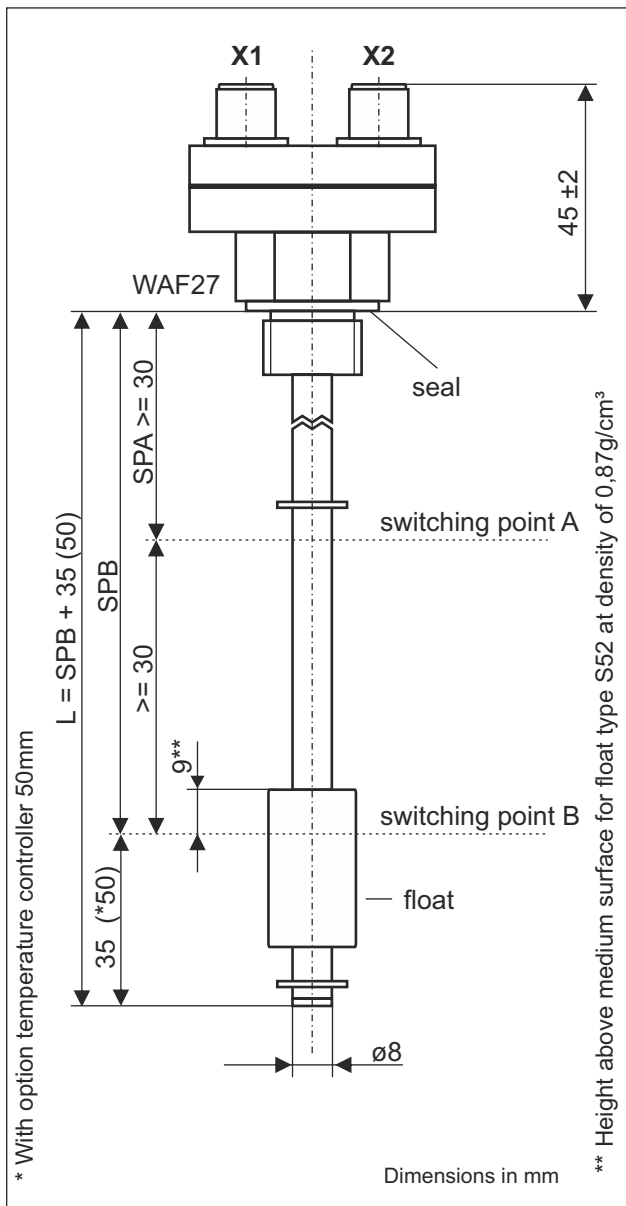

Back to product group

Technical data:

Connection:	Plug-type connector 2x M12x1 4-pole, material TPU, on aluminium housing
Mounting:	thread 1/2", material aluminium
Mounting position:	vertical ± 10°
Seal:	profile seal, material NBR
Sliding tube:	ø8mm material brass or stainless steel, length and material according to customer specification
Float:	ø17,8x32mm, material NBR, type S52
Reed contact:	max. 2x reed contact n.o., contact / n.c. contact or 2x change over contact, function bistable
Switching voltage:	max. 24VDC
Switching current:	150mA
Temperature switching:	optional, power rating see page 16
Temperature sensor:	optional, power rating see page 16
Pressure:	max. 1 bar
Operating temperature:	-20°C to 100°C in medium, -15°C to 70°C above mounting
Protection rating:	IP 65

Data sheet / product information

Mini float switch M60...02.24.8 / M60...08.24.8

plug-type connector M12 4-pole / 5-pole

Mounting M22x1,5

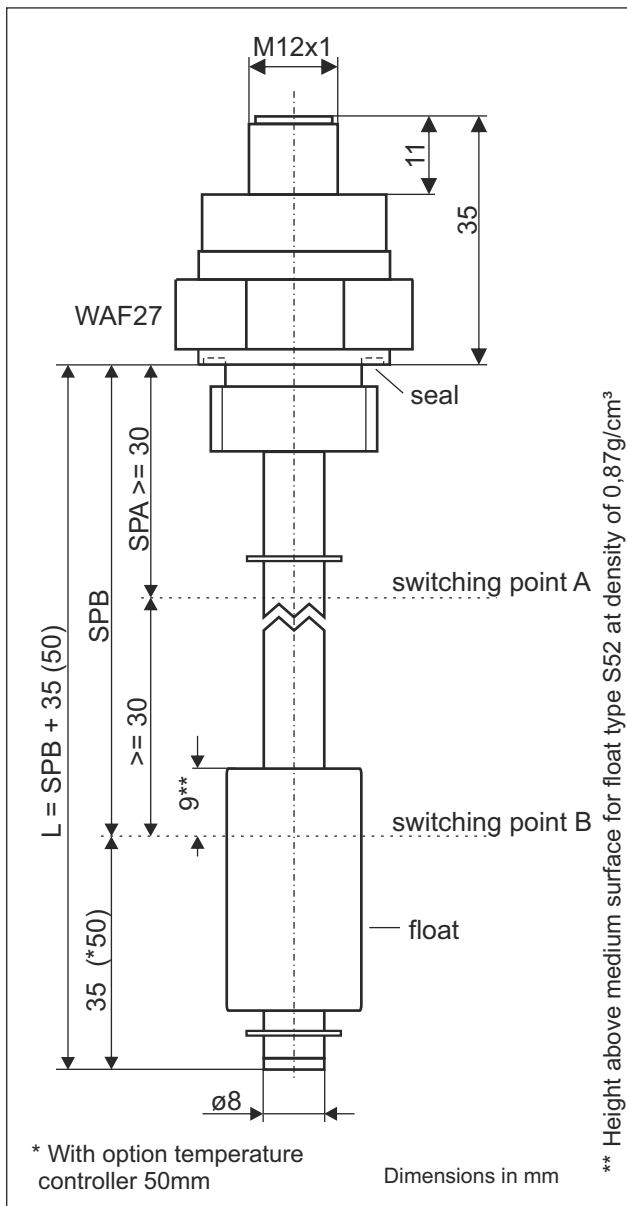

Terminal diagrams

M12 4-pole (02)

Comment: Contacts possible either as n.o. contact or n.c. contact

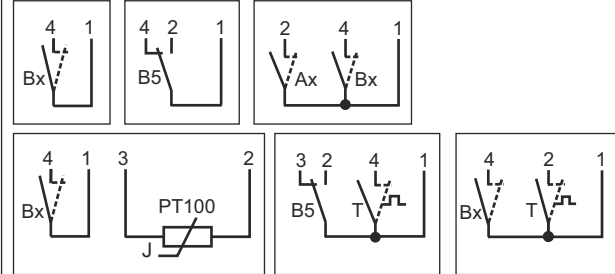

M12 5-pole (08)

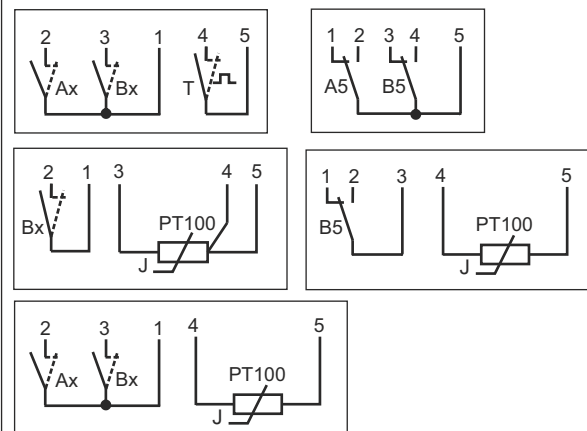

[Back to product group](#)

Technical data:

Connection:	plug-type connector M12x1, 4-pole and 5-pole, material TPU
Mounting:	thread M22x1,5mm, material aluminium
Mounting position:	vertical $\pm 10^\circ$
Seal:	profile seal, material NBR
Sliding tube:	$\varnothing 8$ mm material brass or stainless steel, length and material according to customer specification
Float:	$\varnothing 17,8 \times 32$ mm, material NBR, type S52
Reed contact:	max. 2x reed contact n.o. contact / n.c. contact or 2x change over contact, function bistable
Switching voltage:	max. 24VDC
Switching current:	150mA
Temperature switching:	optional, power rating see page 16
Temperature sensor:	optional, power rating see page 16
Pressure:	max. 1 bar
Operating temperature:	-20°C to 100°C in medium, -15°C to 70°C above mounting
Protection rating:	IP 65

Data sheet / product information

Mini float switch M60...09.13.8

with plug-type connector 2xM12

Mounting 3/4"

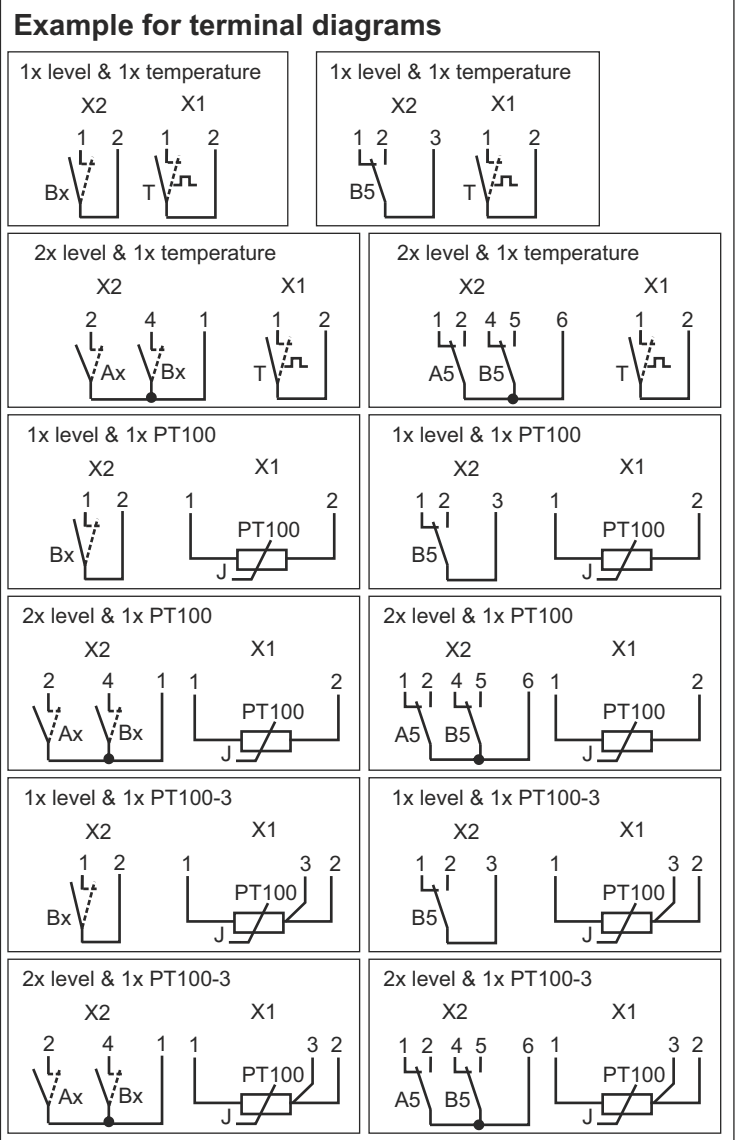
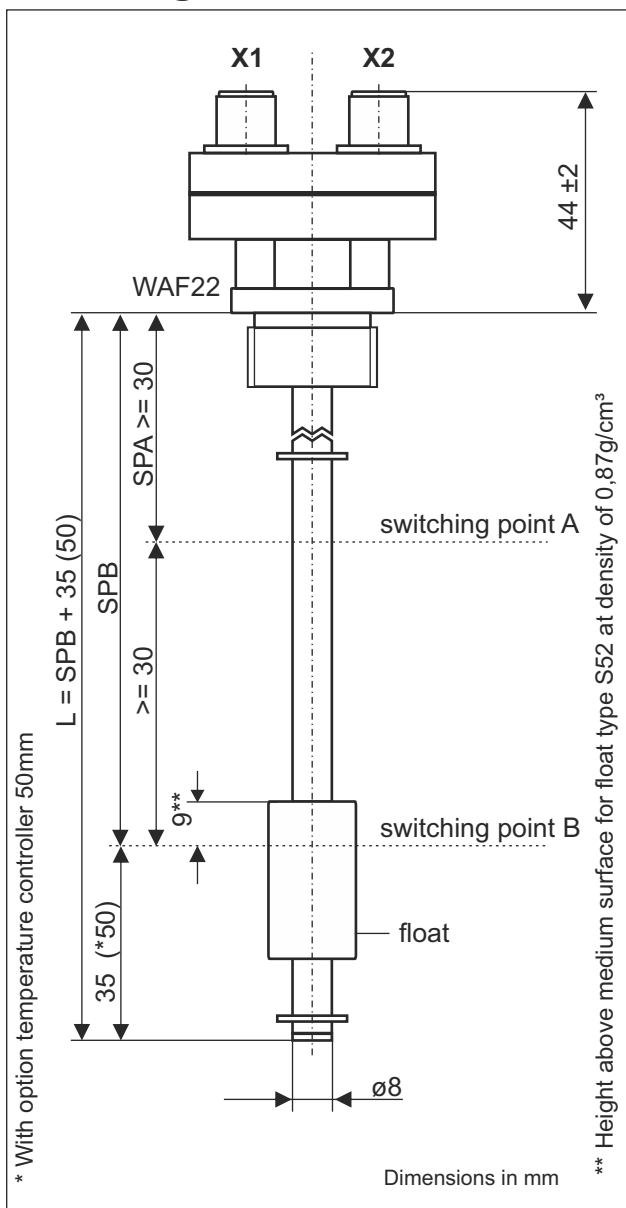

[Back to product group](#)

Technical data:

Connection:	Plug-type connector 2x M12x1 4-pole, material TPU, on alu housing
Mounting:	thread 3/4", material aluminium
Mounting position:	vertical ± 10°
Sliding tube:	ø8mm material brass or stainless steel, length and material according to customer specification
Float:	ø17,8x32mm, material NBR, type S52
Reed contact:	max. 2x reed contacts n.o., contact / n.c. contact or 2x change over contact, function bistable
Switching voltage:	max. 24VDC
Switching current:	150mA
Temperature switching:	optional, power rating see page 16
Temperature sensor:	optional, power rating see page 16
Pressure:	max. 1 bar
Operating temperature:	-20°C to 100°C in medium, -15°C to 70°C above mounting
Protection rating:	IP 65

Data sheet / product information

Mini float switch M60...09.22.8

with plug-type connector 2xM12

Mounting 1"

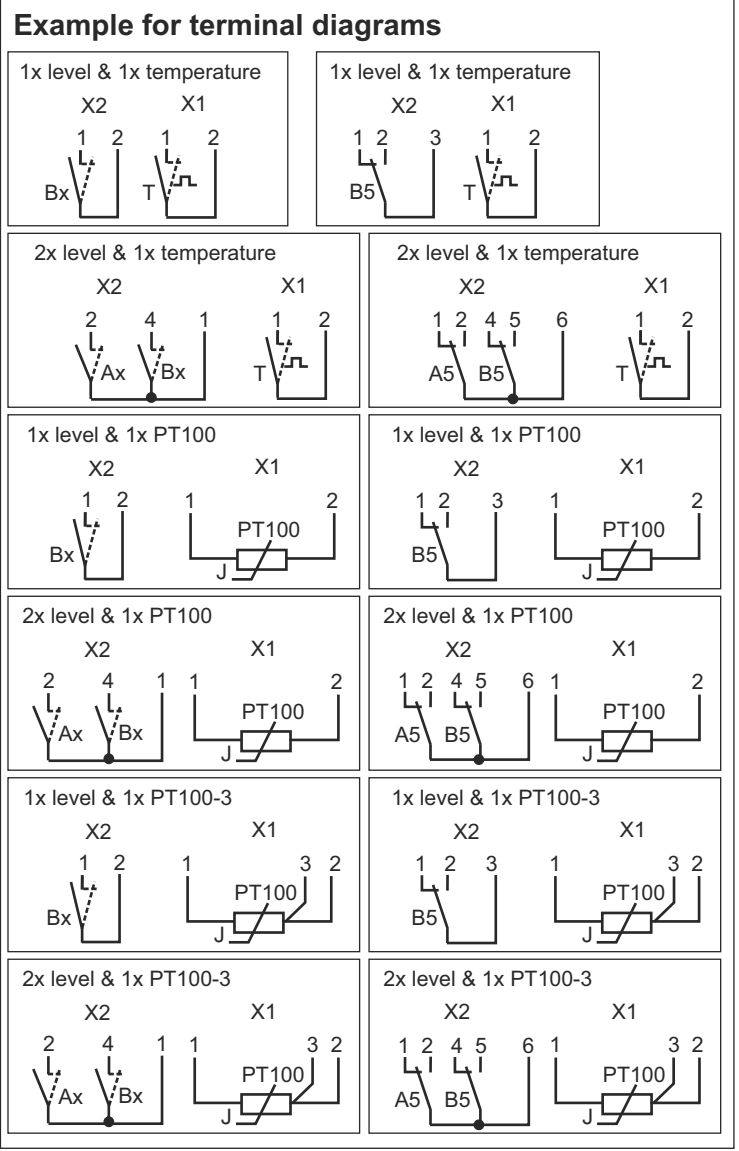
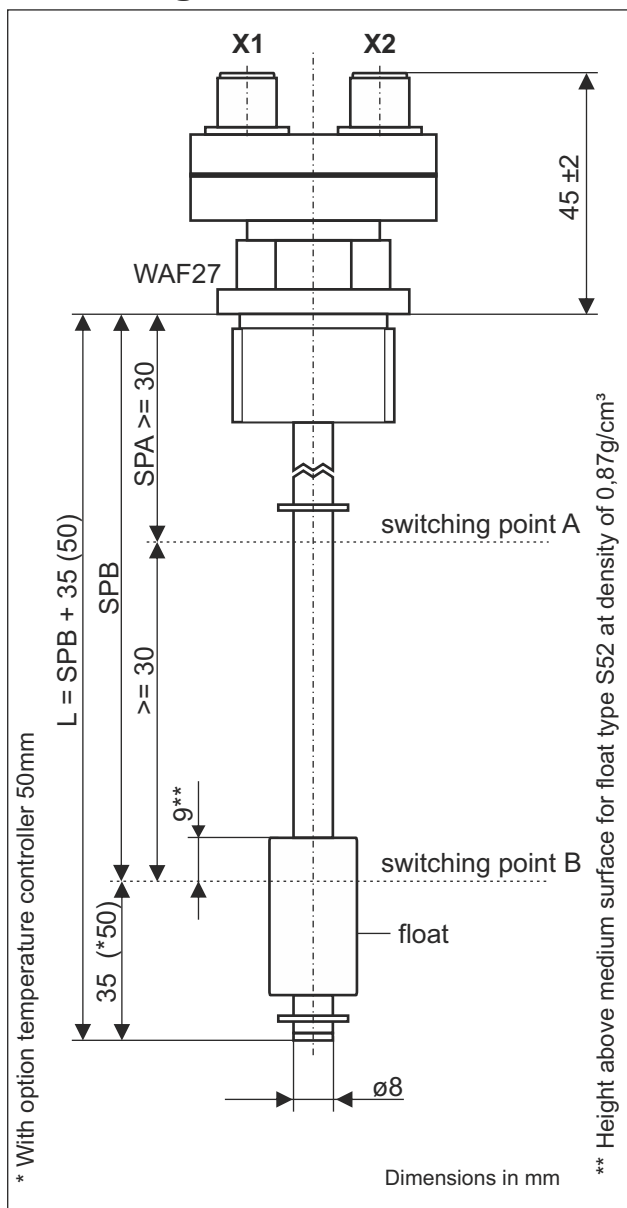

[Back to product group](#)

Technical data:

Connection:	plug-type connector 2x M12x1 4-pole, material TPU, on aluminium housing
Mounting:	thread 1", material aluminium
Mounting position:	vertical ± 10°
Sliding tube:	ø8mm material brass or stainless steel, length and material according to customer specification
Float:	ø17,8x32mm, material NBR, type S52
Reed contact:	max. 2x reed contact, n.o. contact / n.c. contact or 2x change over contact, function bistable
Switching voltage:	max. 24VDC
Switching current:	150mA
Temperature switching:	optional, power rating see page 16
Temperature sensor:	optional, power rating see page 16
Pressure:	max. 1 bar
Operating temperature:	-20°C to 100°C in medium, -15°C to 70°C above mounting
Protection rating:	IP 65

Data sheet / product information

Mini float switch M60...09.46.8

with plug-type connector 2xM12

Mounting round flange

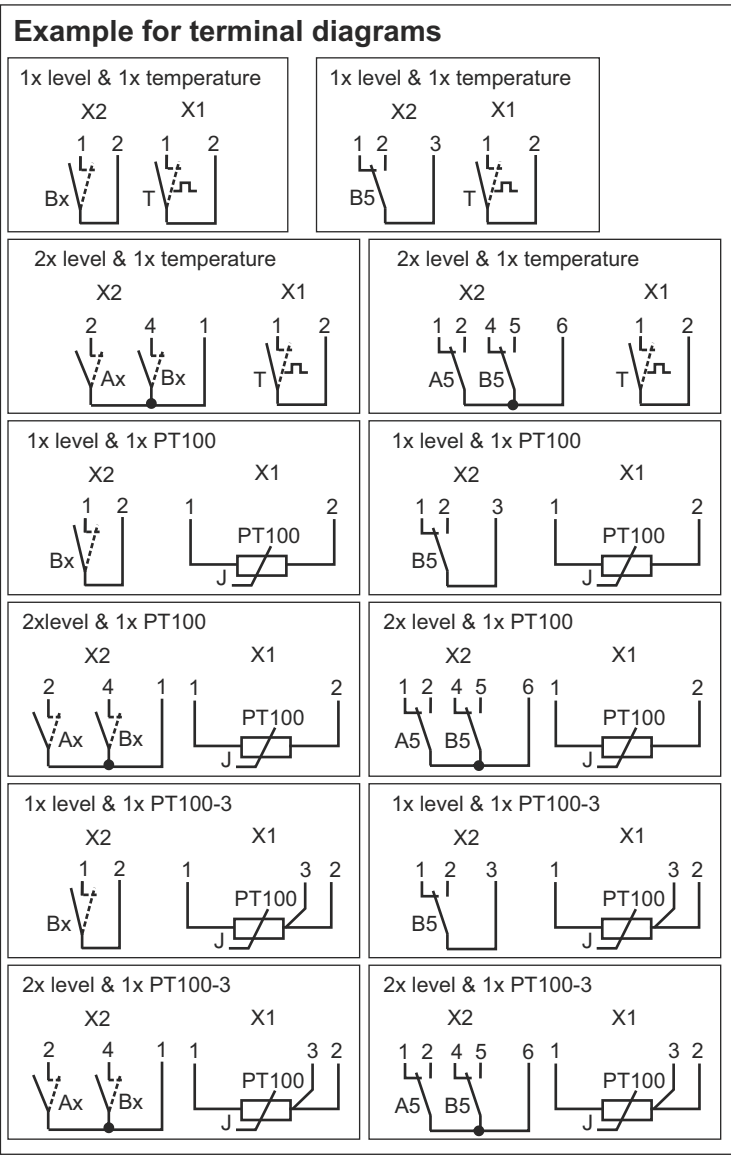
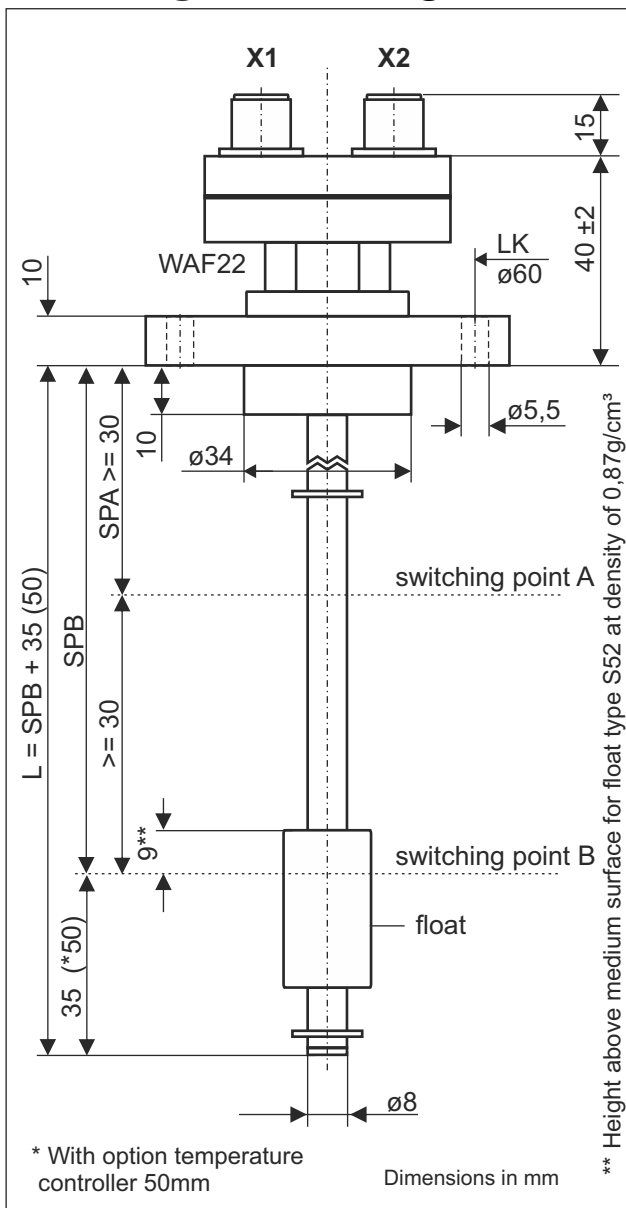

Back to product group

Technical data:

Connection:	plug-type connector 2x M12x1, 4-pole, material TPU, on alu housing
Mounting:	round flange AD 74mm, material aluminium
Mounting position:	vertical ± 10°
Sliding tube:	ø8mm material brass or stainless steel, length and material according to customer specification
Float:	ø17,8x32mm, material NBR, type S52
Reed contact:	max. 2x reed contacts, n.o. contact / n.c. Contact or 2x change over contact, function bistable
Switching voltage:	max. 24VDC
Switching current:	150mA
Temperature switching:	optional, power rating see page 16
Temperature sensor:	optional, power rating see page 16
Pressure:	max. 1 bar
Operating temperature:	-20°C to 100°C in medium, -15°C to 70°C above mounting
Protection rating:	IP 65

Hotline +49 (0)7389 90920 - eMail info@engler-msr.de

Data sheet / product information

Mini float switch M60...09.01.8

with plug-type connector 2xM12

Mounting M20x1,5

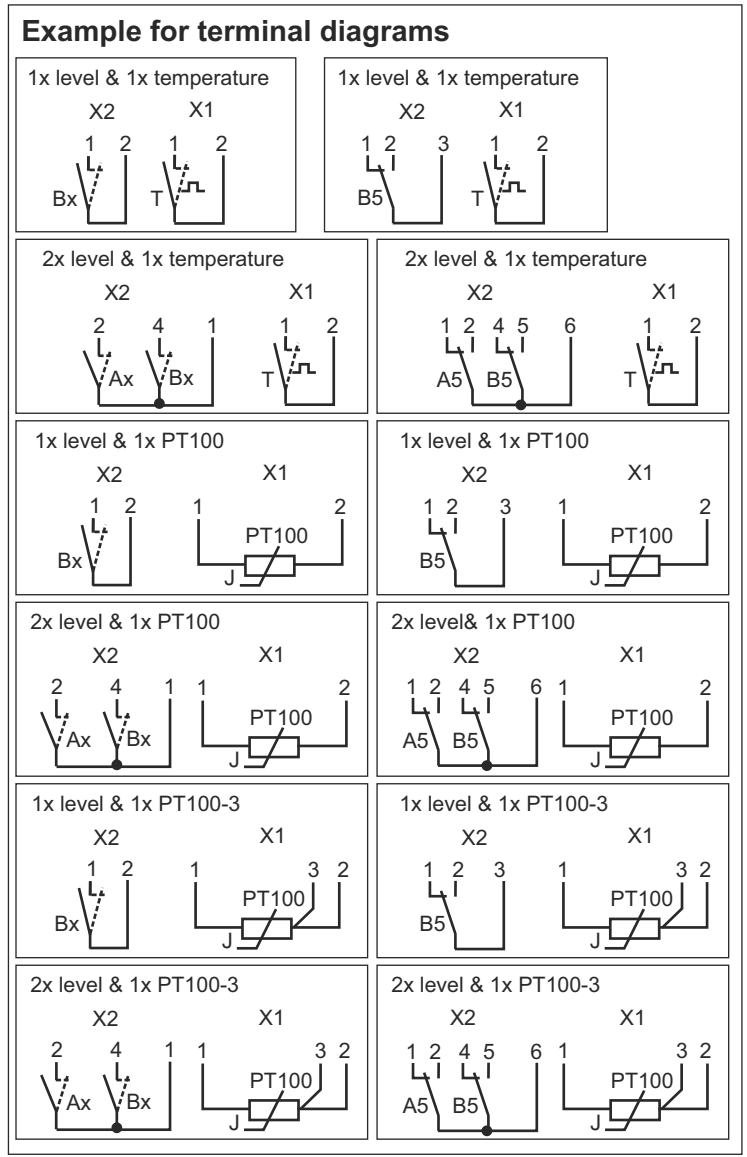
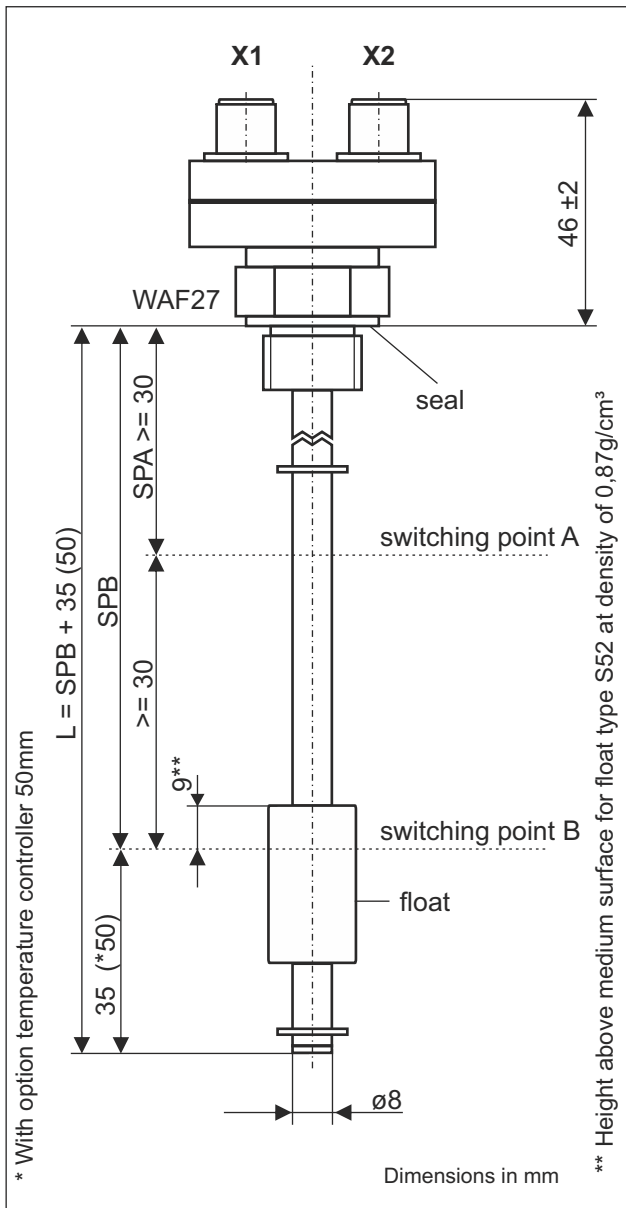

[Back to product group](#)

Technical data:

Connection:	connector 2x M12x1 4-pole, material TPU, on aluminium housing
Mounting:	thread M20x1,5, material aluminium
Mounting position:	vertical ± 10°
Seal:	profile seal, material NBR
Sliding tube:	ø8mm material brass or stainless steel, length and material according to customer specification
Float:	ø17,8x32mm, material NBR, type S52
Reed contact:	max. 2x reed contacts, n.o. contact / n.c. Contact or 2x change over contact, function bistable
Switching voltage:	max. 24VDC
Switching current:	150mA
Temperature switching:	optional, power rating see page 16
Temperature sensor:	optional, power rating see page 16
Pressure:	max. 1 bar
Operating temperature:	-20°C to 100°C in medium, -15°C to 70°C above mounting
Protection rating:	IP 65

Data sheet / product information

Mini float switch M60...09.24.8

with plug-type connector 2xM12

Mounting M22x1,5

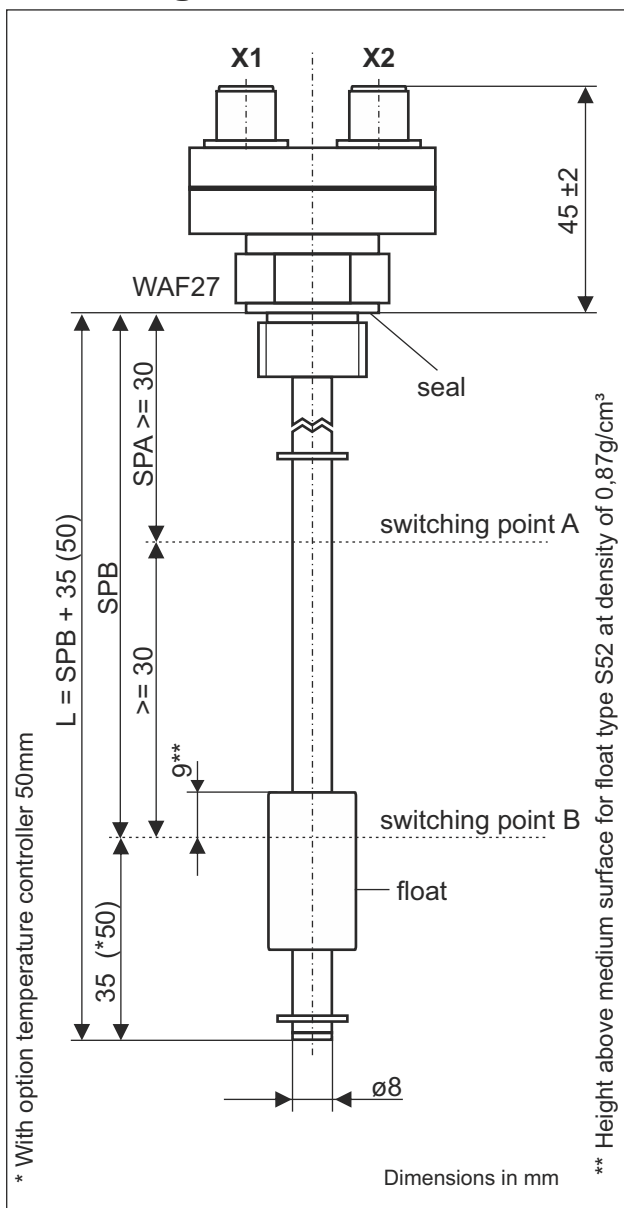

Example for terminal diagrams

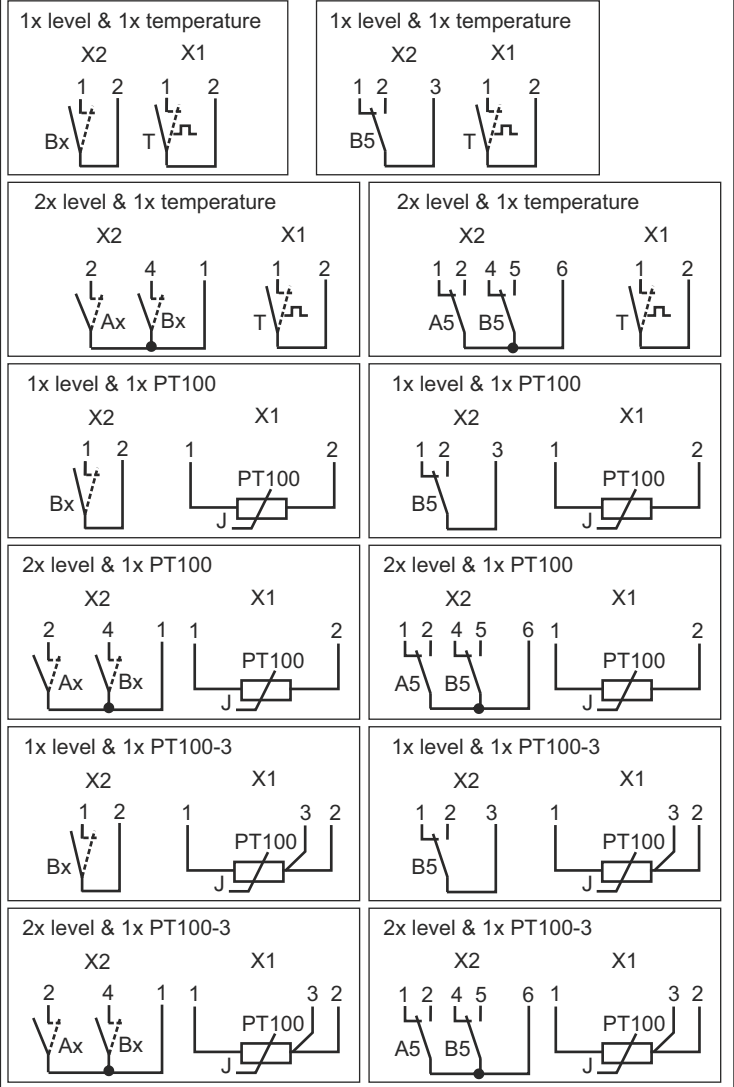

[Back to product group](#)

Technical data:

Connection:	plug-type connector 2x M12x1, 4-pole, material TPU, on aluminium housing
Mounting:	thread M22x1,5, material aluminium
Mounting position:	vertical $\pm 10^\circ$
Seal:	profile seal, material NBR
Sliding tube:	$\varnothing 8$ mm material brass or stainless steel, length and material according to customer specification
Float:	$\varnothing 17,8 \times 32$ mm, material NBR, type S52
Reed contact:	max. 2x reed contacts, n.o. contact / n.c. Contact or 2x change over contact, function bistable
Switching voltage:	max. 24VDC
Switching current:	150mA
Temperature switching:	optional, power rating see page 16
Temperature sensor:	optional, power rating see page 16
Pressure:	max. 1 bar
Operating temperature:	-20°C to 100°C in medium, -15°C to 70°C above mounting
Protection rating:	IP 65

Data sheet / product information

Mini float switch M60...09.33.8

with plug-type connector 2xM12

Mounting M24x1,5

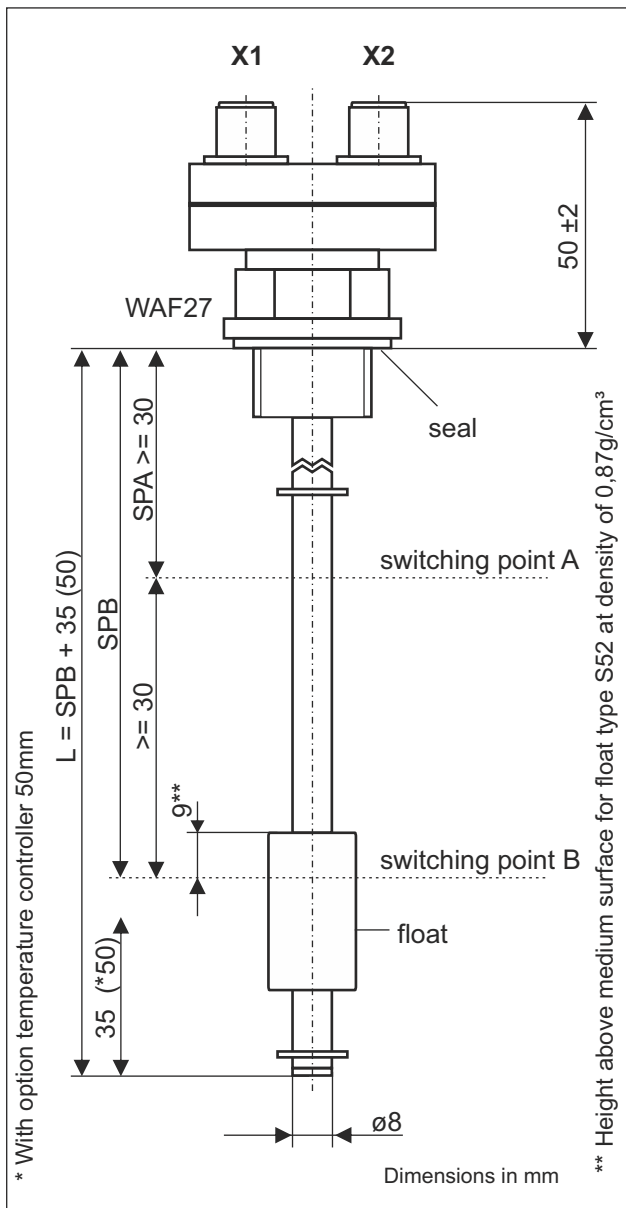

Example for terminal diagrams

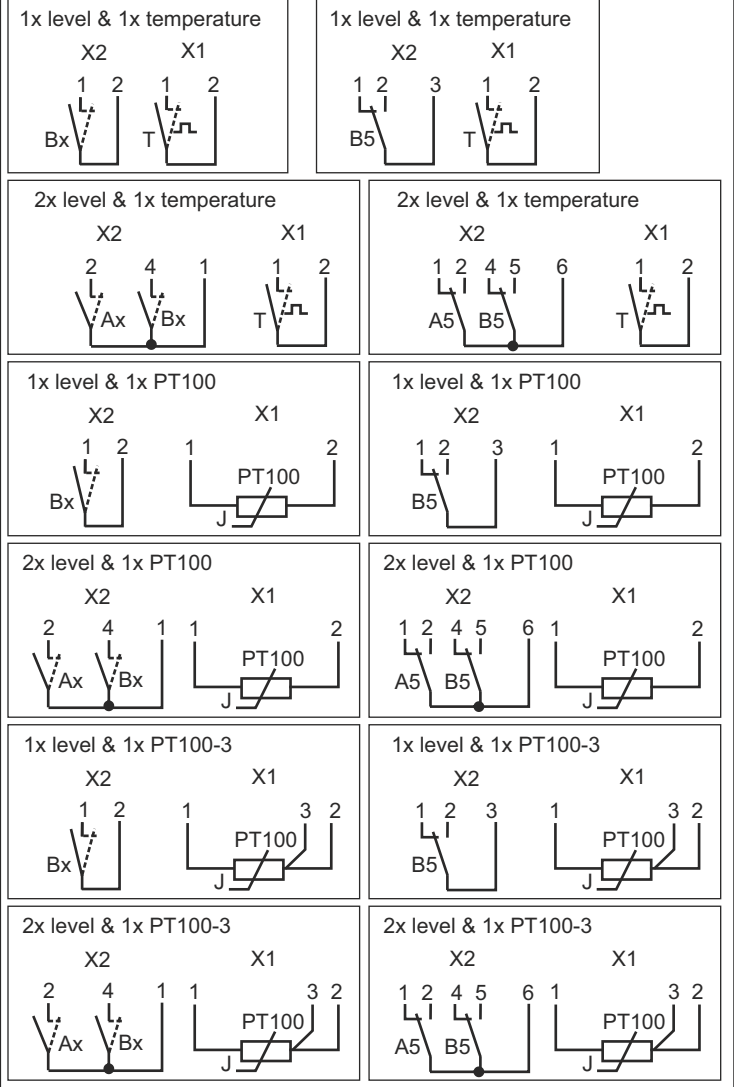

Back to product group

Technical data:

Connection:	plug-type connector 2x M12x1, 4-pole, material TPU, on alu housing
Mounting:	thread M24x1,5, material aluminium
Mounting position:	vertical $\pm 10^\circ$
Seal:	profile seal, material NBR
Sliding tube:	$\varnothing 8$ mm material brass or stainless steel, length and material according to customer specification
Float:	$\varnothing 17,8 \times 32$ mm, material NBR, type S52
Reed contact:	max. 2x reed contacts, n.o. contact / n.c. contact or change over contact, function bistable
Switching voltage:	max. 24VDC
Switching current:	150mA
Temperature switching:	optional, power rating see page 16
Temperature sensor:	optional, power rating see page 16
Pressure:	max. 1 bar
Operating temperature:	-20°C to 100°C in medium, -15°C to 70°C above mounting
Protection rating:	IP 65

Data sheet / product information

Mini float switch M60...10.02.8

with terminal housing

Mounting 1/2"

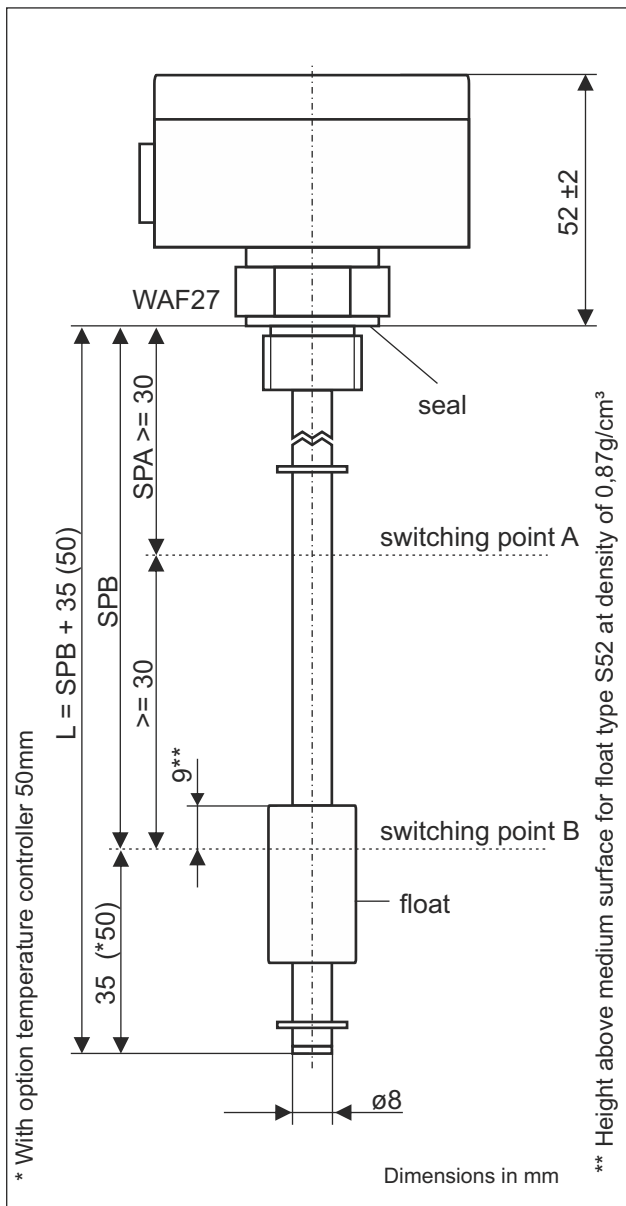

Example for Terminal diagrams

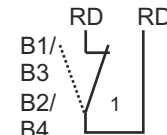

1 x n.o. contact/n.c. contact
 E.g. order key
 M60.1.B1.80.10.02.8

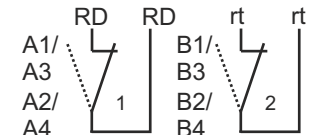

2 x n.o. contact/n.c. contact
 E.g. order key
 M60.2.A2.B4.60.200.10.02.8

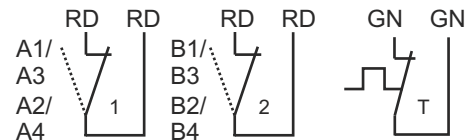

2 x n.o. contact/n.c. contact 1x temperature switch
 E.g. order key
 M60.2.A2.B4.60.200.10.02.8.700

[Back to product group](#)

Technical data:

Connection:	terminal connection $1,5mm^2$ in the housing, cable entry at the housing M16x1,5, housing material aluminium, colour grey
Mounting:	thread 1/2", material aluminium
Mounting position:	vertical $\pm 10^\circ$
Seal:	material NBR
Sliding tube:	$\varnothing 8mm$ material brass or stainless steel, length and material according to customer specification
Float:	$\varnothing 17,8 \times 32mm$, material NBR, type S52
Reed contact:	max. 2x reed contacts n.o. contacts / n.c. contacts, function bistable
Switching voltage:	max. 230VAC for one switching point; for two switching points max. 24VDC
Switching current:	1A for one switching point; for two switching points 150mA
Temperature switching:	optional, power rating see page 16
Temperature sensor:	optional, power rating see page 16
Pressure:	max. 1 bar
Operating temperature:	$-20^\circ C$ to $100^\circ C$ in medium, $-15^\circ C$ to $70^\circ C$ above mounting
Protection rating:	IP 65

Data sheet / product information

Mini float switch M60...10.23.8

with terminal housing

Mounting oval flange

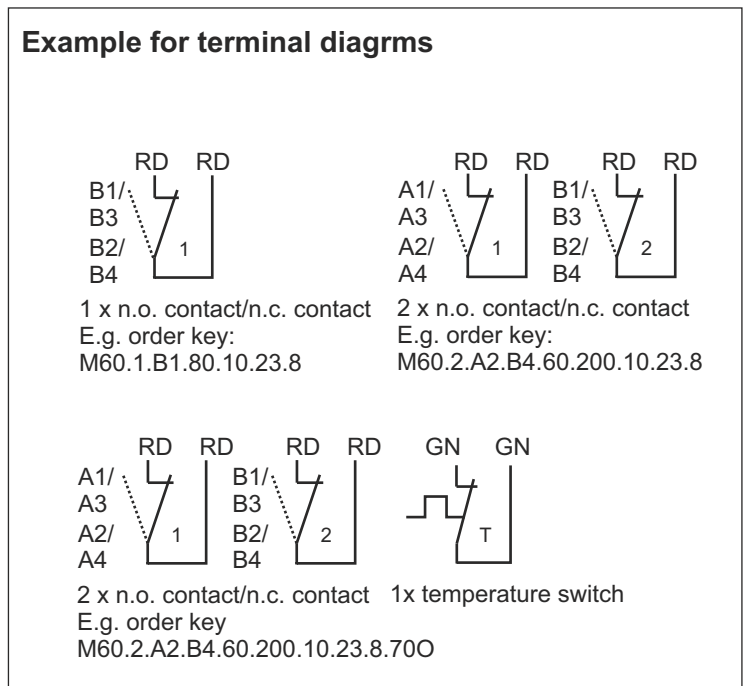
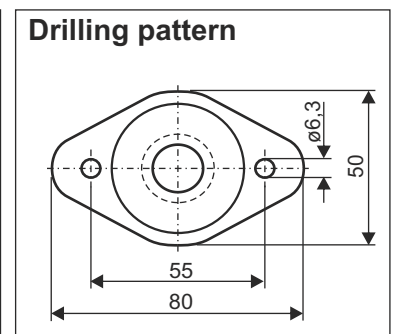
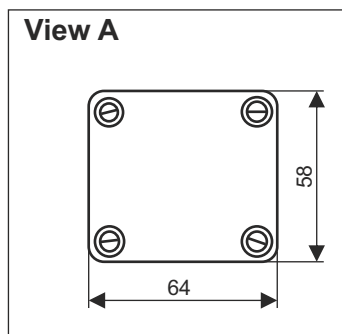
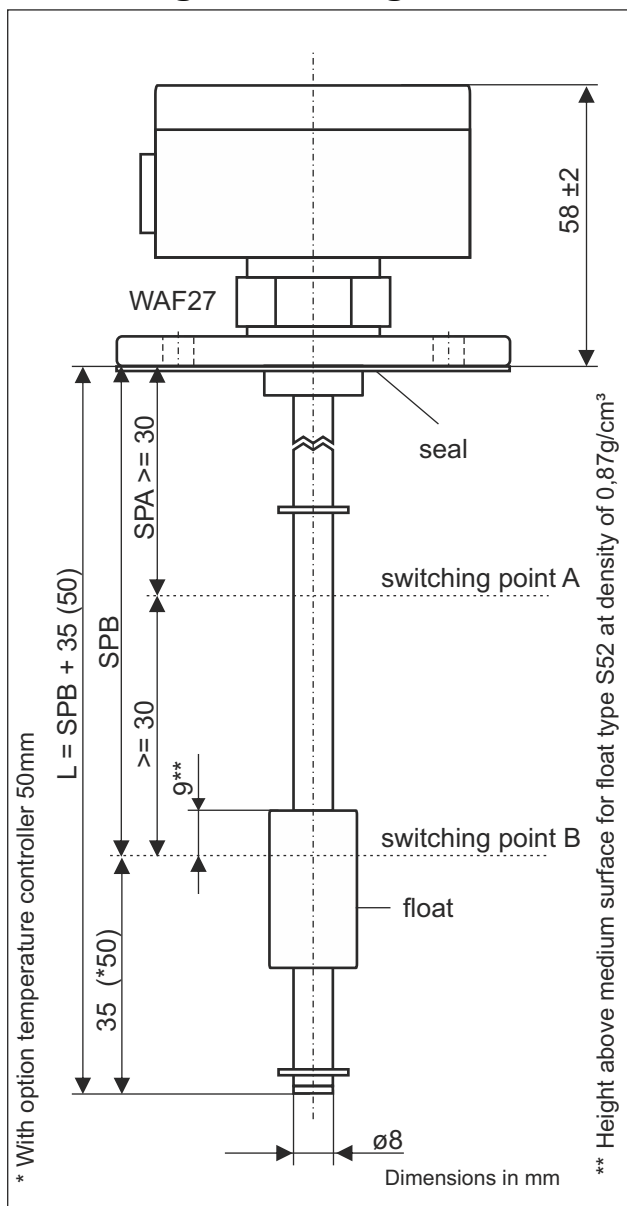

[Back to product group](#)

Technical data:

Connection:	terminal connection 1,5mm ² in the housing, cable entry at the housing M16x1,5, housing material aluminium, colour grey
Mounting:	oval flange, material PA6 GF 30 (Makrolon)
Mounting position:	vertical ± 10°
Seal:	material NBR
Sliding tube:	ø8mm material brass or stainless steel, length and material according to customer specification
Float:	ø17,8x32mm, material NBR, type S52
Reed contact:	max. 2x reed contacts n.o. contacts / n.c. contacts, function bistable
Switching voltage:	max. 230VAC for one switching point; for two switching points max. 24VDC
Switching current:	1A for one switching point; for two switching points 150mA
Temperature switching:	optional, power rating see page 16
Temperature sensor:	optional, power rating see page 16
Pressure:	max. 1 bar
Operating temperature:	-20°C to 100°C in medium, -15°C to 70°C above mounting
Protection rating:	IP 65

Hotline +49 (0)7389 90920 - eMail info@engler-msr.de

Data sheet / product information

Mini float switch M60...10.13.8

with terminal housing

Mounting 3/4"

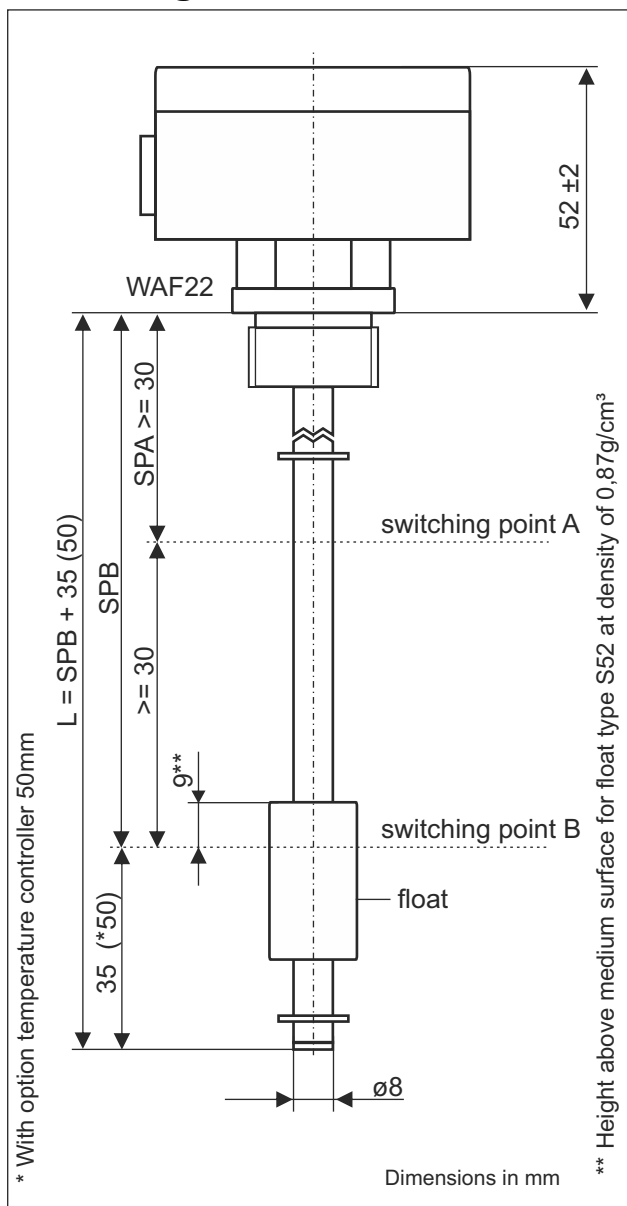

Example for Terminal diagrams

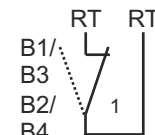

1 x n.o. contact/n.c. contact
 E.g. order key
 M60.1.B1.80.10.13.8

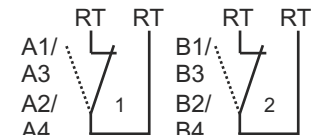

2 x n.o. contact/n.c. contact
 E.g. order key
 M60.2.A2.B4.60.200.10.13.8

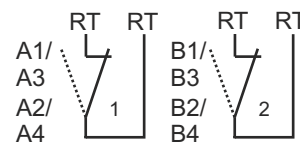

2 x n.o. contact/n.c. contact
 E.g. order key
 M60.2.A2.B4.60.200.10.13.8.700

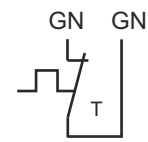

1x temperature switch

[Back to product group](#)

Technical data:

Connection:	terminal connection 1,5mm ² in the housing 64x58x35mm (wxdxh), cable entry at the housing M16x1,5, housing material aluminium, colour grey thread 3/4", material aluminium
Mounting:	vertical $\pm 10^\circ$
Mounting position:	vertical $\pm 10^\circ$
Sliding tube:	$\varnothing 8$ mm material brass or stainless steel, length and material according to customer specification
Float:	$\varnothing 17,8 \times 32$ mm, material NBR, type S52
Reed contact:	max. 2x reed contacts n.o. contacts / n.c. contacts, function bistable
Switching voltage:	max. 230VAC for one switching point; for two switching point max. 24VDC
Switching current:	1A for one switching point; for two switching points 150mA
Temperature switching:	optional, power rating see page 16
Temperature sensor:	optional, power rating see page 16
Pressure:	max. 1 bar
Operating temperature:	-20°C to 100°C in medium, -15°C to 70°C above mounting
Protection rating:	IP 65

Data sheet / product information

Mini float switch M60...10.46.8

with terminal housing

Mounting round flange

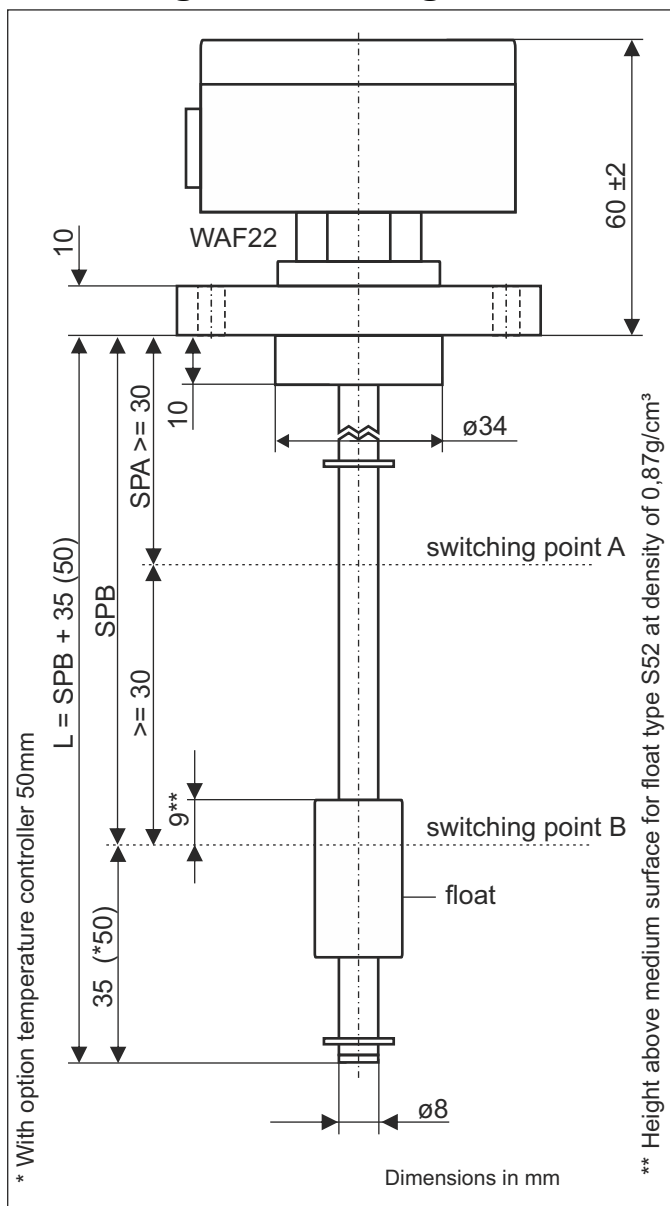

Example for Terminal diagrams

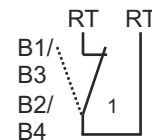

1 x n.o. contact/n.c. contact
E.g. order key
M60.1.B1.80.10.46.8

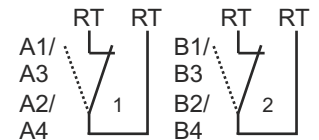

2 x Sn.o. contact/n.c. contact
E.g. order key
M60.2.A2.B4.60.200.10.46.8

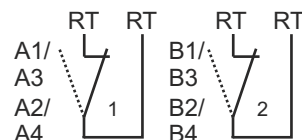

2 x n.o. contact/n.c. contact
E.g. order key
M60.2.A2.B4.60.200.10.46.8.700

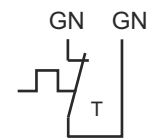

1x temperature switch

Drill plan

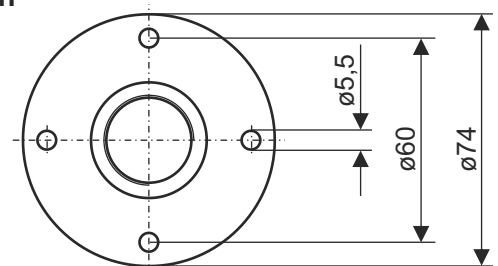

[Back to product group](#)

Technical data:

Connection:	terminal connection 1,5mm ² in the housing, cable entry at the housing M16x1,5, housing material aluminium, colour grey
Mounting:	round flange AD74mm, material aluminium
Mounting position:	vertical ± 10°
Sliding tube:	ø8mm material brass or stainless steel, length and material according to customer specification
Float:	ø17,8x32mm, material NBR, type S52
Reed contact:	max. 2x reed contacts n.o. contacts / n.c. contacts, function bistable
Switching voltage:	max. 230VAC for one switching point; for two switching point max. 24VDC
Switching current:	1A for one switching point; for two switching points 150mA
Temperature switching:	optional, power rating see page 16
Temperature sensor:	optional, power rating see page 16
Pressure:	max. 1 bar
Operating temperature:	-20°C to 100°C in medium, -15°C to 70°C above mounting
Protection rating:	IP 65

Data sheet / product information

Mini float switch M60...10.01.8

with terminal housing

Mounting M20x1,5

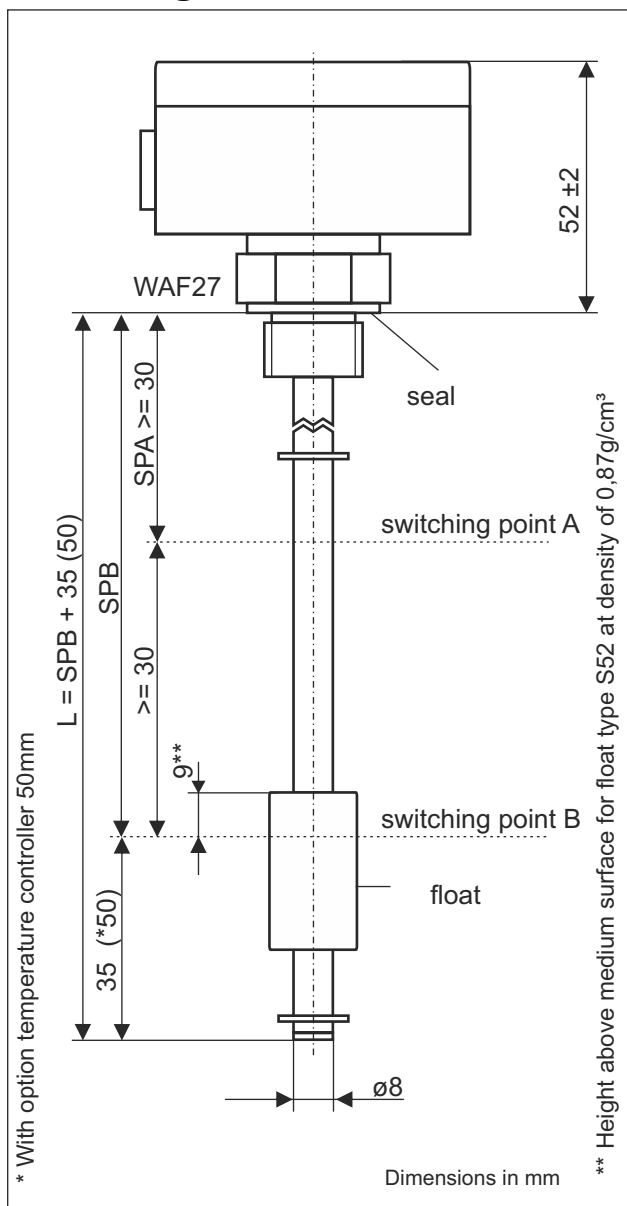

Example for Terminal diagrams

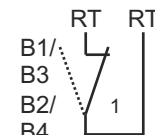

1 x n.o. contact/n.c. contact
E.g. order key
M60.1.B1.80.10.01.8

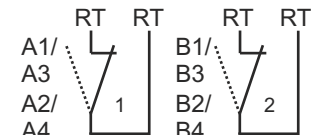

2 x n.o. contact/n.c. contact
E.g. order key
M60.2.A2.B4.60.200.10.01.8

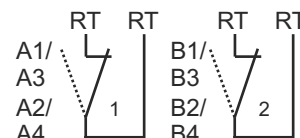

2 x n.o. contact/n.c. contact
E.g. order key
M60.2.A2.B4.60.200.10.01.8.700

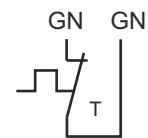

1x temperature switch

[Back to product group](#)

Technical data:

Connection:	terminal connection 1,5mm ² in the housing, cable entry at the housing M16x1,5, housing material aluminium, colour grey
Mounting:	thread M 20x1,5, material aluminium
Mounting position:	vertical ± 10°
Seal:	material NBR
Sliding tube:	ø8mm material brass or stainless steel, length and material according to customer specification
Float:	ø17,8x32mm, material NBR, type S52
Reed contact:	max. 2x reed contacts, n.o. contacts / n.c. contacts, function bistable
Switching voltage:	max. 230VAC for one switching point; for two switching point max. 24VDC
Switching current:	1A for one switching point; for two switching points 150mA
Temperature switching:	optional, power rating see page 16
Temperature sensor:	optional, power rating see page 16
Pressure:	max. 1 bar
Operating temperature:	-20°C to 100°C in medium, -15°C to 70°C above mounting
Protection rating:	IP 65

Data sheet / product information

Mini float switch M60...10.22.8

with terminal housing

Mounting 1"

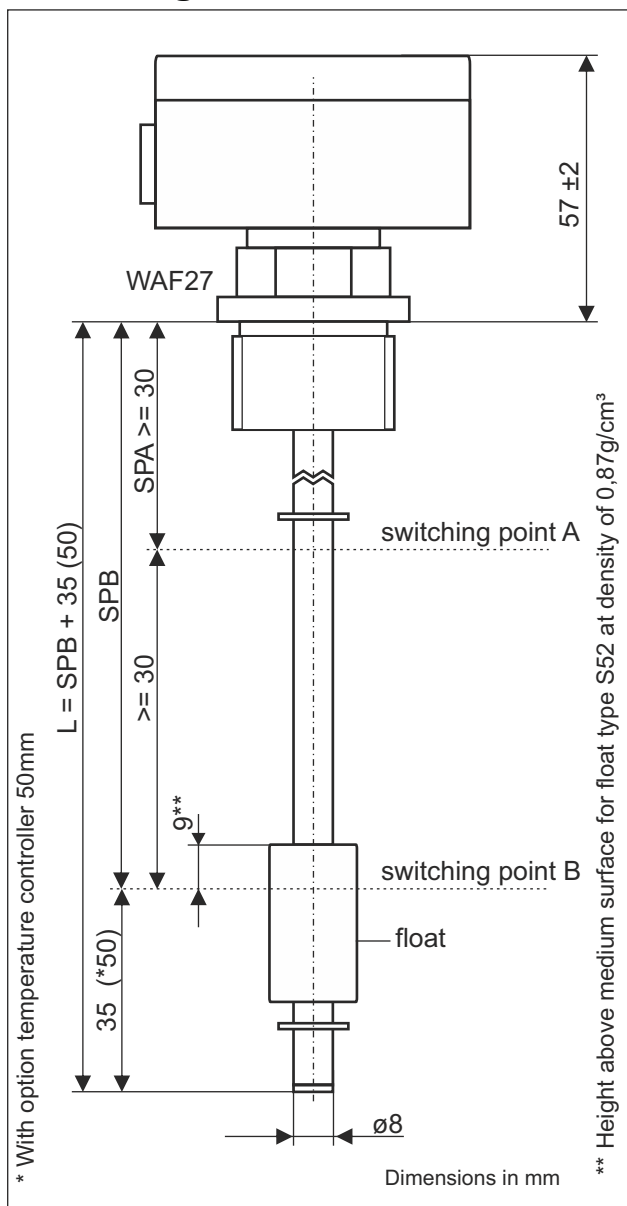

Example for Terminal diagrams

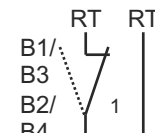

1 x n.o. contact/n.c. contact
E.g. order key:
M60.1.B1.80.10.22.8

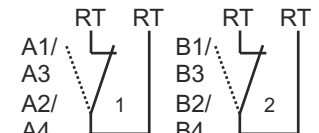

2 x n.o. contact/n.c. contact
E.g. order key:
M60.2.A2.B4.60.200.10.22.8

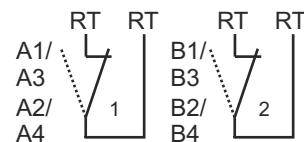

2 x n.o. contact/n.c. contact
E.g. order key
M60.2.A2.B4.60.200.10.22.8.700

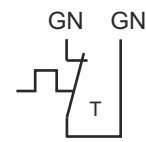

1x temperature switch

[Back to product group](#)

Technical data:

Connection:	terminal connection 1,5mm ² in the housing, cable entry at the housing M16x1,5, housing material aluminium, colour grey
Mounting:	thread 1", material aluminium
Mounting position:	vertical ± 10°
Sliding tube:	Ø8mm material brass or stainless steel, length and material according to customer specification
Float:	Ø17,8x32mm, material NBR, type S52
Reed contact:	max. 2x reed contacts n.o. contacts / n.c. contacts, function bistable
Switching voltage:	max. 230VAC for one switching point; for two switching point max. 24VDC
Switching current:	1A for one switching point; for two switching points 150mA
Temperature switing:	optional, power rating see page 16
Temperature sensor:	optional, power rating see page 16
Pressure:	max. 1 bar
Operating temperature:	-20°C to 100°C in medium, -15°C to 70°C above mounting
Protection rating:	IP 65

Data sheet / product information

Mini float switch M60...10.33.8

with terminal housing

Mounting M24x1,5

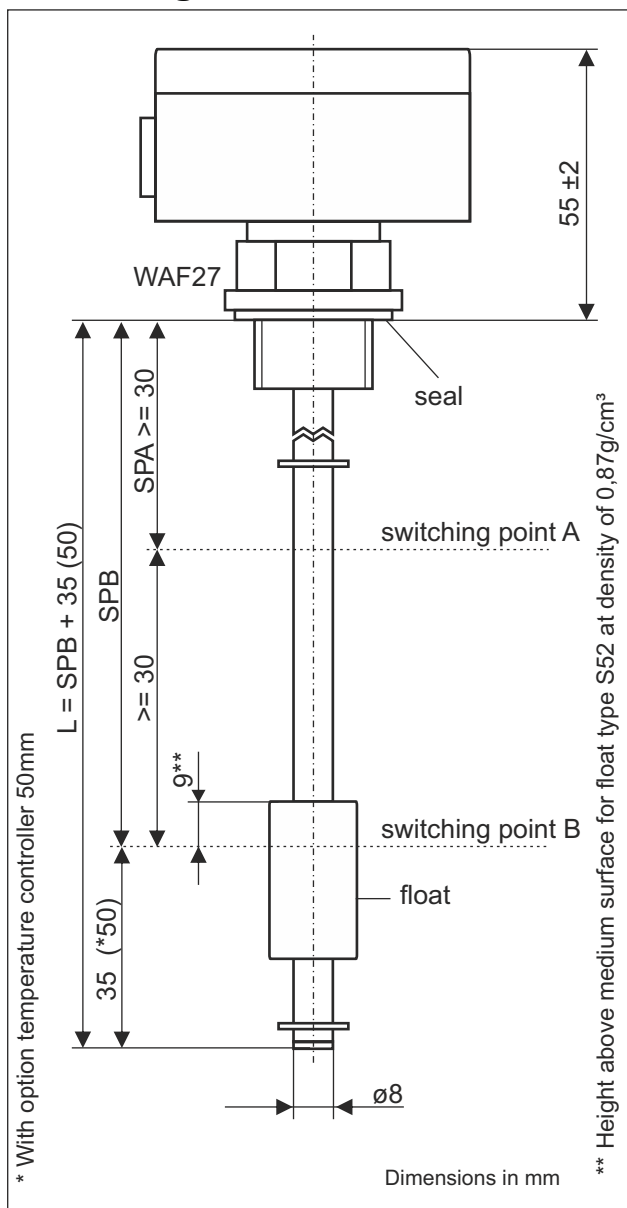

Example for Terminal diagrams

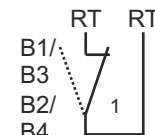

1 x n.o. contact/n.c. contact
E.g. order key:
M60.1.B1.80.10.33.8

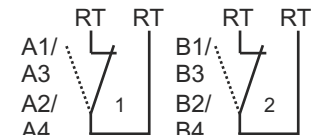

2 x n.o. contact/n.c. contact
E.g. order key:
M60.2.A2.B4.60.200.10.33.8

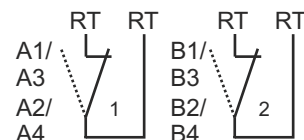

2 x n.o. contact/n.c. contact
E.g. order key:
M60.2.A2.B4.60.200.10.33.8.700

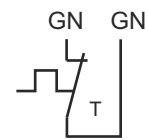

1x temperature switch

[Back to product group](#)

Technical data:

Connection:	terminal connection 1,5mm ² in the housing, cable entry at the housing M16x1,5, housing material aluminium, colour grey
Mounting:	thread M 24x1,5, material aluminium
Mounting position:	vertical ± 10°
Seal:	material NBR
Sliding tube:	ø8mm material brass or stainless steel, length and material according to customer specification
Float:	ø17,8x32mm, material NBR, type S52
Reed contact:	max. 2x reed contacts n.o. contacts / n.c. contacts, function bistable
Switching voltage:	max. 230VAC for one switching point; for two switching points max. 24VDC
Switching current:	1A for one switching point; for two switching points 150mA
Temperature switching:	optional, power rating see page 16
Temperature sensor:	optional, power rating see page 16
Pressure:	max. 1 bar
Operating temperature:	-20°C to 100°C in medium, -15°C to 70°C above mounting
Protection rating:	IP 65

Data sheet / product information

Mini float switch M60...10.24.8

with terminal housing

Mounting M22x1,5

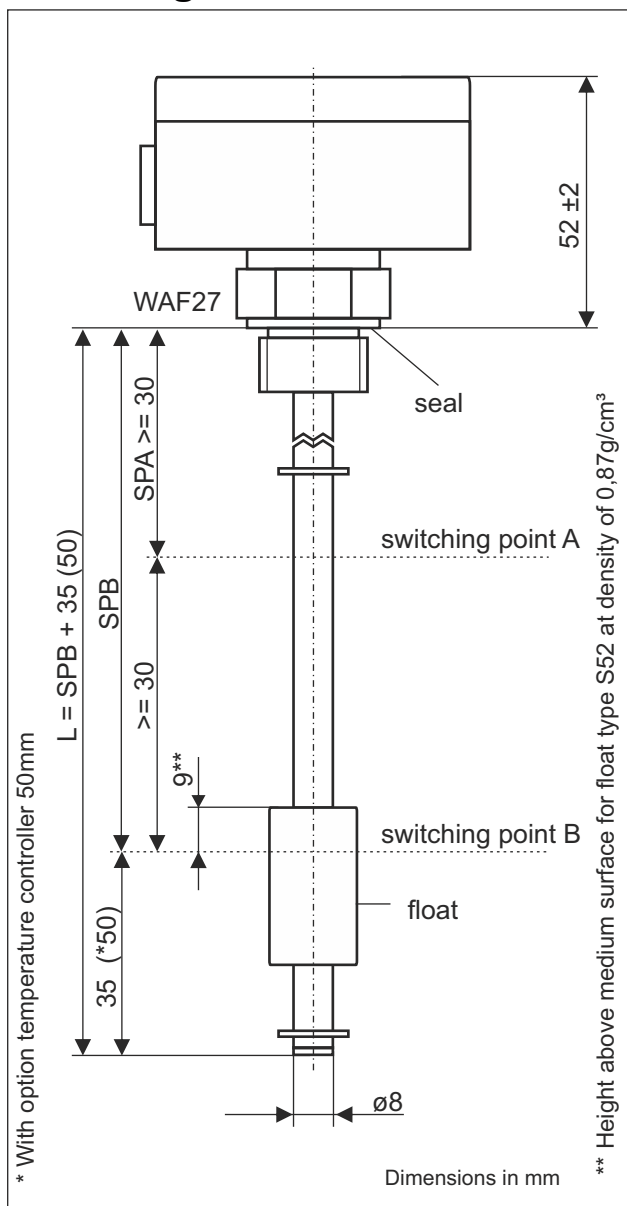

Example for Terminal diagrams

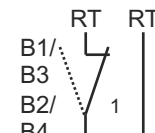

1 x n.o. contact/n.c. contact
E.g. order key:
M60.1.B1.80.10.24.8

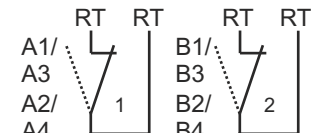

2 x Sn.o. contact/n.c. contact
E.g. order key:
M60.2.A2.B4.60.200.10.24.8

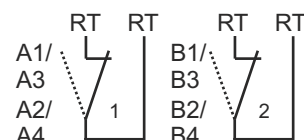

2 x n.o. contact/n.c. contact
E.g. order key:
M60.2.A2.B4.60.200.10.24.8.700

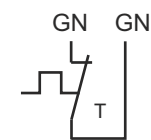

1x temperature switch

[Back to product group](#)

Technical data:

Connection:	terminal connection 1,5mm ² in the housing, cable entry at the housing M16x1,5, housing material aluminium, colour grey
Mounting:	thread M 22x1,5, material aluminium
Mounting position:	vertical ± 10°
Seal:	material NBR
Sliding tube:	ø8mm material brass or stainless steel, length and material according to customer specification
Float:	ø17,8x32mm, material NBR, type S52
Reed contact:	max. 2x reed contacts n.o. contacts / n.c. contacts, function bistable
Switching voltage:	max. 230VAC for one switching point; for two switching points max. 24VDC
Switching current:	1A for one switching point; for two switching points 150mA
Temperature switching:	optional, power rating see page 16
Temperature sensor:	optional, power rating see page 16
Pressure:	max. 1 bar
Operating temperature:	-20°C to 100°C in medium, -15°C to 70°C above mounting
Protection rating:	IP 65

Data sheet / product information

Mini float switch M60...13.01.8

with plug-type connector 6-pole

Mounting M20x1,5

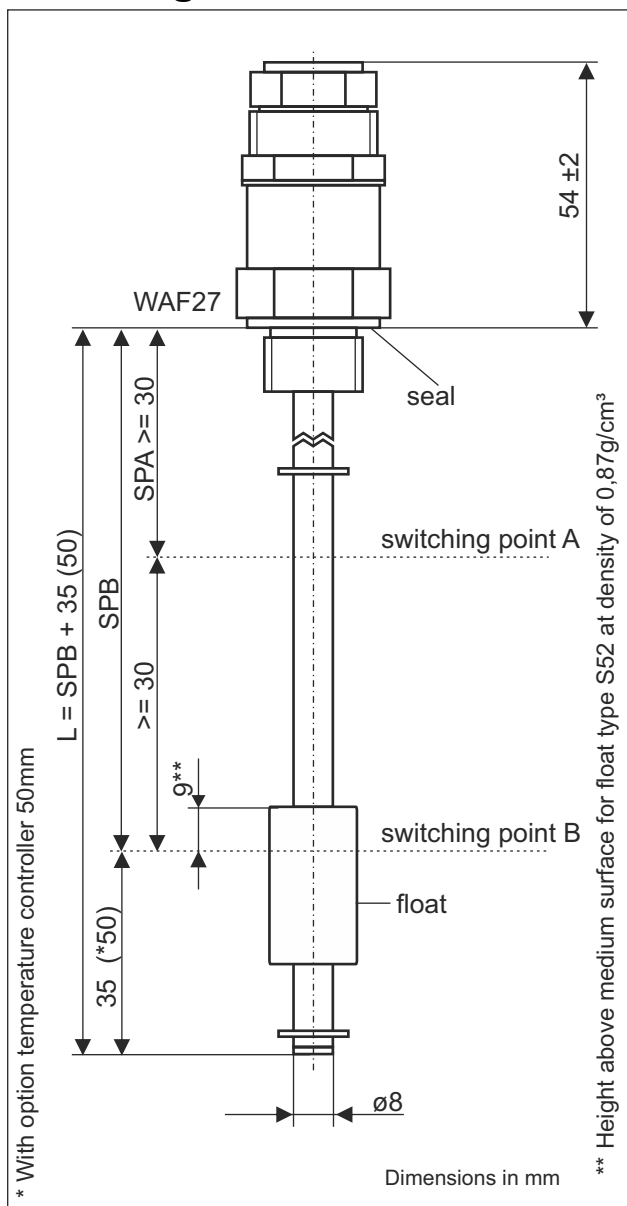

Example for Terminal plan

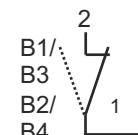

1 x n.o. contact/n.c. contact
E.g. order key:
M60.1.B1.80.13.01.8

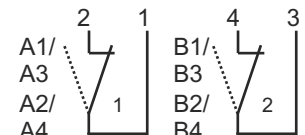

2 x n.o. contact/n.c. contact
E.g. order key:
M60.2.A2.B4.60.200.13.01.8

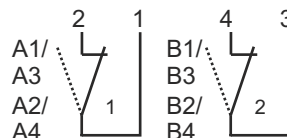

2 x n.o. contact/n.c. contact
E.g. order key::
M60.2.A2.B4.60.200.13.01.8.700

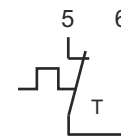

1x temperature switching

[Back to product group](#)

Technical data:

Connection:	6 pole + PE connector acc. DIN EN 175201-804 (DIN 43651), material PET
Mounting:	thread M 20x1,5, material aluminium
Mounting position:	vertical ± 10°
Seal:	profile seal, material NBR
Sliding tube:	ø8mm material brass or stainless steel, length and material according to customer specification
Float:	ø17,8x32mm, material NBR, type S52
Reed contact:	max. 2x reed contacts n.o. contacts / n.c. contacts, function Bistable
Switching voltage:	max. 230VAC for one switching point; for two switching point max. 24VDC
Switching current:	1A for one switching point; for two switching points 150mA
Temperature switching:	optional, power rating see page 16
Temperature sensor:	optional, power rating see page 16
Pressure:	max. 1 bar
Operating temperature:	-20°C to 100°C in medium, -15°C to 70°C above mounting
Protection rating:	IP 65

Hotline +49 (0)7389 90920 - eMail info@engler-msr.de

TS14 - 11.01.2021 - be - G: je, ph - TS_EKat_M60_Typenfamilie.cdr

Data sheet / product information

Mini float switch M60...13.22.8

with plug-type connector 6-pole

Mounting 1"

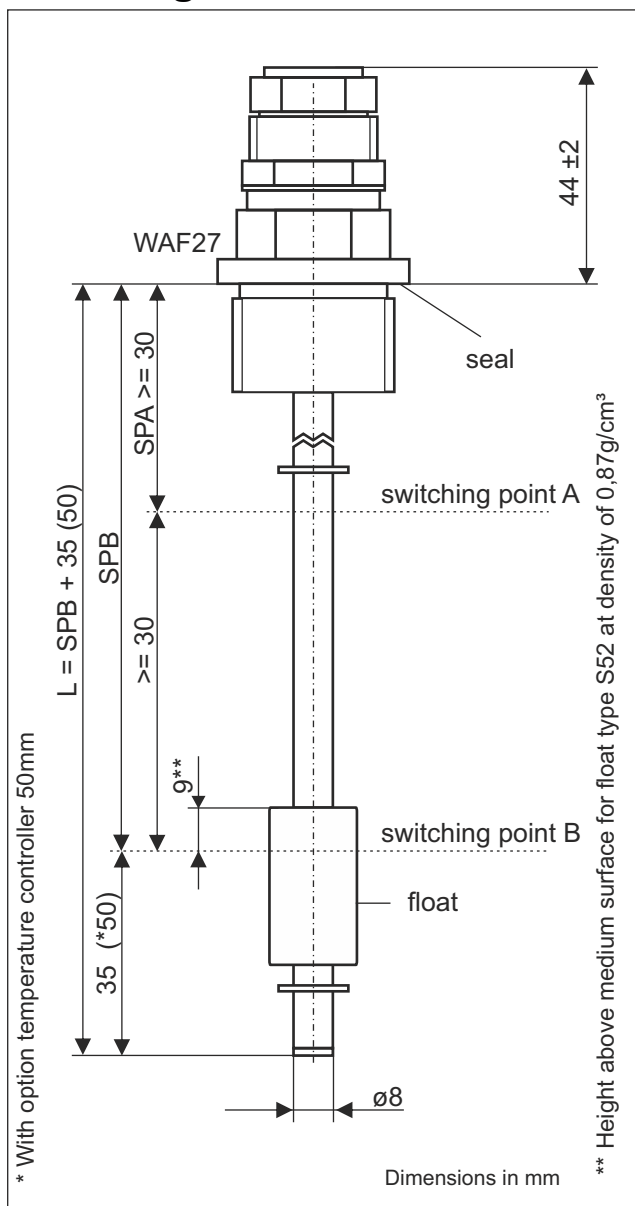

Example for Terminal plan

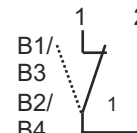

1 x n.o. contact/n.c. contact
E.g. order key:
M60.1.B1.80.13.22.8

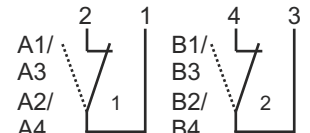

2 x n.o. contact/n.c. contact
E.g. order key:
M60.2.A2.B4.60.200.13.22.8

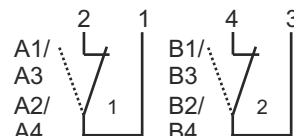

2 x n.o. contact/n.c. contact
E.g. order key:
M60.2.A2.B4.60.200.13.22.8.700

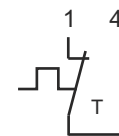

1x temperature switching

[Back to product group](#)

Technical data:

Connection:	6 pole + PE connector acc. DIN EN 175201-804 (DIN 43651), material PET
Mounting:	thread 1", material aluminium
Mounting position:	vertical $\pm 10^\circ$
Seal:	profile seal, material NBR
Sliding tube:	$\varnothing 8$ mm material brass or stainless steel, length and material according to customer specification
Float:	$\varnothing 17,8 \times 32$ mm, material NBR, type S52
Reed contact:	max. 2x reed contacts n.o. contacts / n.c. contacts, function Bistable
Switching voltage:	max. 230VAC for one switching point; for two switching point max. 24VDC
Switching current:	1A for one switching point; for two switching points 150mA
Temperature switching:	optional, power rating see page 16
Temperature sensor:	optional, power rating see page 16
Pressure:	max. 1 bar
Operating temperature:	-20°C to 100°C in medium, -15°C to 70°C above mounting
Protection rating:	IP 65

Data sheet / product information

Mini float switch M60.2...10.2

in stainless steel with plug-type connector M12

Mounting 1"

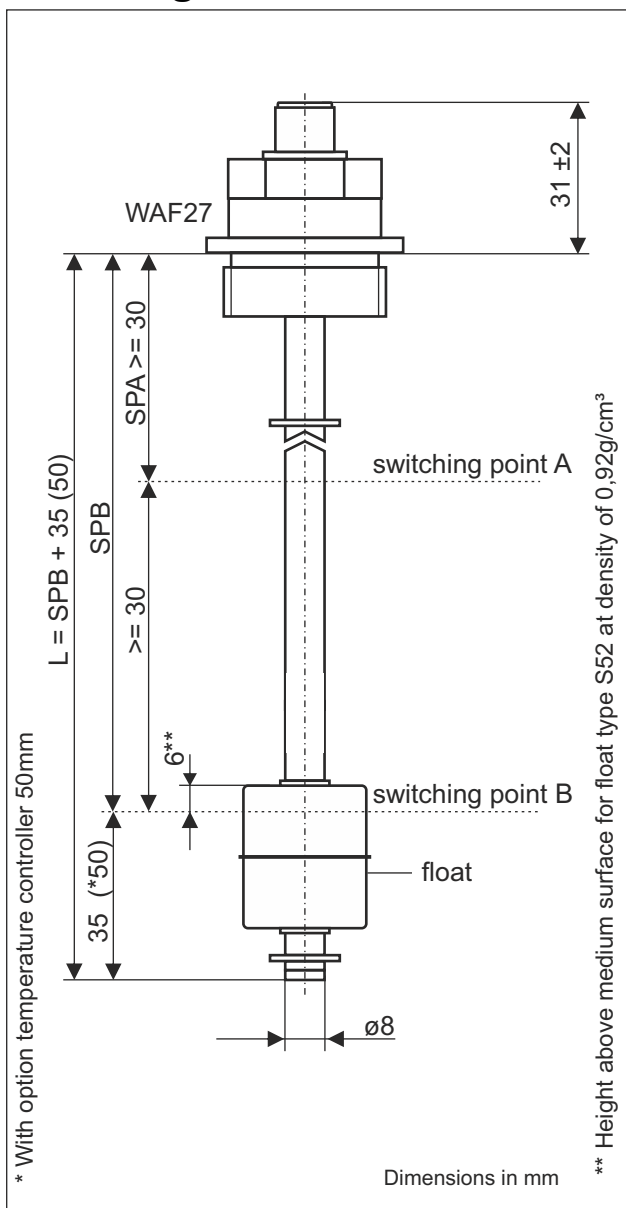

Example for terminal diagrams 4-pole

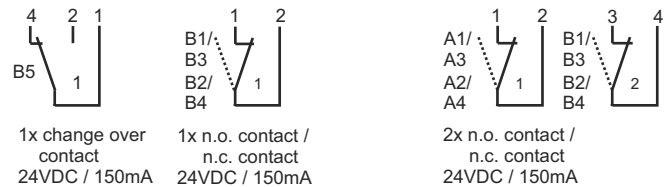

Example for terminal diagrams 5-pole

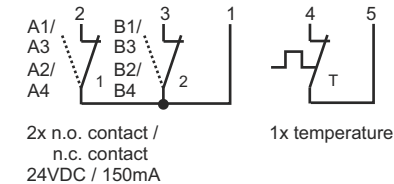

Example for terminal diagrams 6-pole

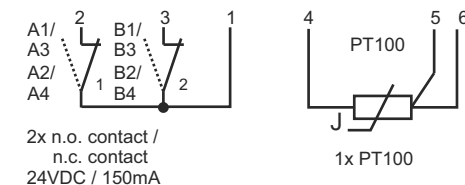

Example for terminal diagrams 8-pole

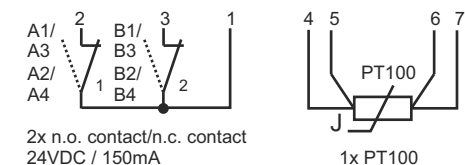

[Back to product group](#)

Technical data:

Connection:	plug-type connector M12x1, 4-pole, 5-pole, 6-pole or 8-pole according to customer specification
Mounting:	thread 1", material stainless steel
Mounting position:	vertical $\pm 10^\circ$
Sliding tube:	$\varnothing 8$ mm material stainless steel, length according to customer specification
Float:	$\varnothing 17,8 \times 32$ mm, material stainless steel, type S12
Reed contact:	max. 2x reed contacts n.o. contacts / n.c. contacts, function bistable
Switching voltage:	max. 24VDC
Switching current:	150mA
Temperature switching:	optional, power rating see page 16
Temperature sensor:	optional, power rating see page 16
Pressure:	max. 1 bar
Operating temperature:	-20°C to 100°C in medium, -15°C to 70°C above mounting
Protection rating:	IP 65

Data sheet / product information

Mini float switch M60.2...01.10.2

in stainless steel with plug-type connector 3-pole DIN EN 175301-803 mounting 1"

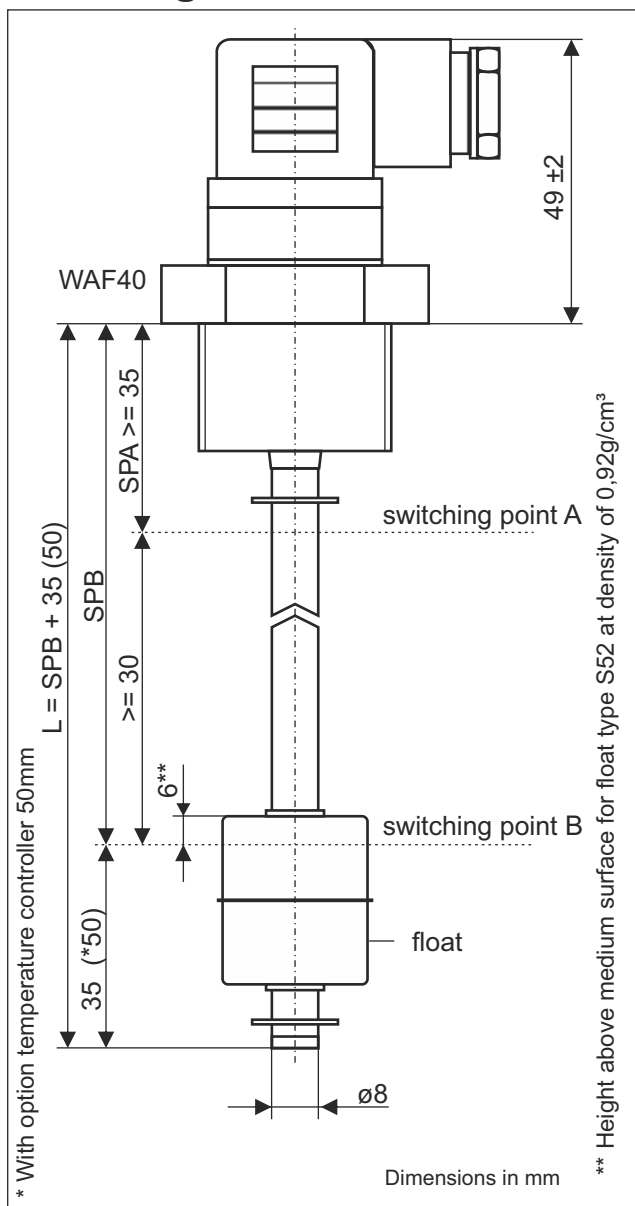

Example for terminal diagrams

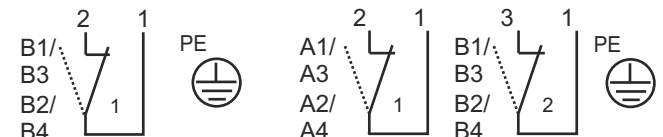

1 x n.o./n.c. contact
e.g. Order key:
M60.2.B1.80.01.10.2

2 x n.o./n.c. Contact
e.g. Order key:
M60.2.A2.B4.60.200.01.10.2

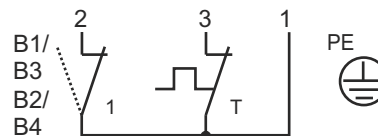

1 x n.o./n.c. contact 1x temperature switch
e.g. Order key:
M60.2.B4.200.01.10.2.700

[Back to product group](#)

Technical data:

Connection:	3 pole + PE connector according DIN EN 175301-803 (DIN 43650), material PA
Mounting:	thread 1", material stainless steel
Mounting position:	vertical $\pm 10^\circ$
Sliding tube:	$\phi 8$ mm material stainless steel, length according to customer specification
Float:	$\phi 17,8 \times 32$ mm, material stainless steel, type S12
Reed contact:	max. 2x reed contacts n.o. contacts / n.c. contacts, function bistable
Switching voltage:	max. 230VAC for one switching point; for two switching point max. 24VDC
Switching current:	1A for one switching point; for two switching point 150mA
Temperature switching:	optional, power rating see page 16
Temperature sensor:	optional, power rating see page 16
Pressure:	max. 1 bar
Operating temperature:	-20°C to 100°C in medium, -15°C to 70°C above mounting
Protection rating:	IP 65

Data sheet / product information

Mini float switch M60...01.27.8

in stainless steel with plug-type connector 3-pole DIN EN 175301-803 mounting 1/2"

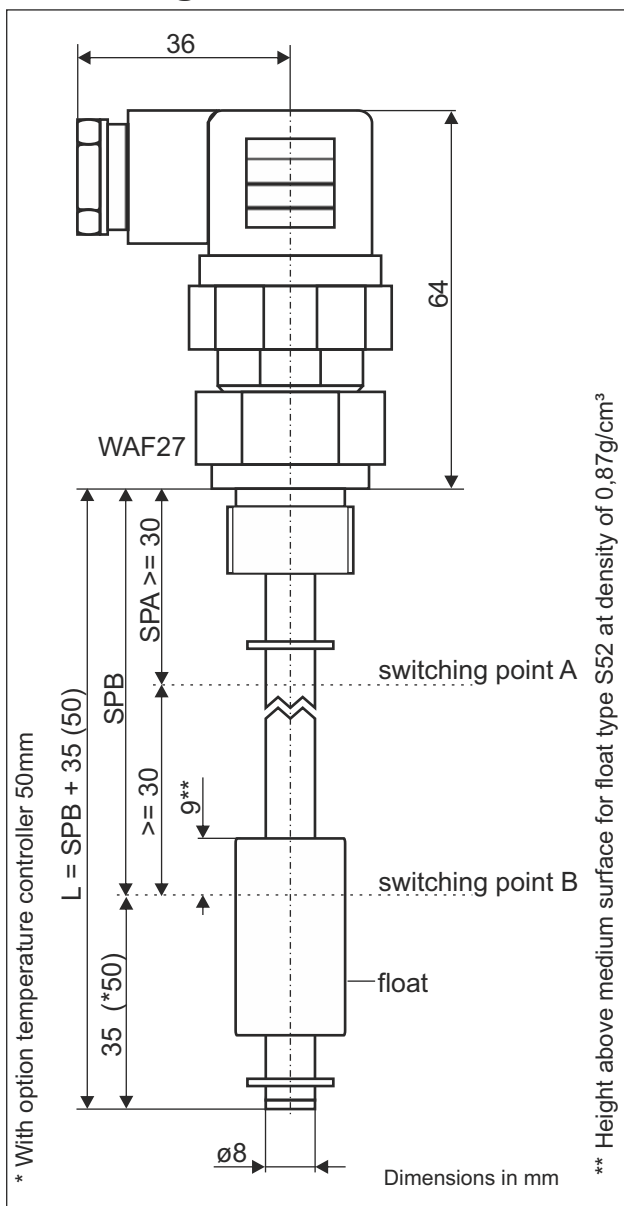

Terminal diagrams 3-pole + PE DIN EN 175301-803 (further connection alternatives upon requests)

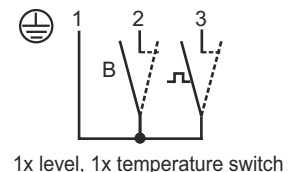
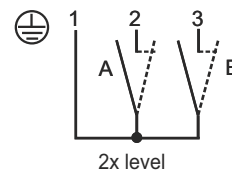
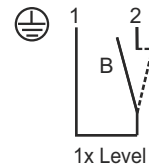

Comment: Contacts possible either as n.o. contact or n.c. contact

[Back to product group](#)

Technical data:

Connection:	3 pole + PE connector according DIN EN 175301-803 (DIN 43650), material PA
Mounting:	thread 1/2", material stainless steel
Mounting position:	vertical $\pm 10^\circ$
Sliding tube:	$\varnothing 8$ mm material stainless steel, length according to customer specification
Float:	$\varnothing 17,8 \times 32$ mm, material NBR, type S52
Reed contact:	max. 2x reed contacts n.o. contacts / n.c. contacts, function bistable
Switching voltage:	max. 230VAC for one switching point; for two switching point max. 24VDC
Switching current:	1A for one switching point; for two switching point 150mA
Temperature switching:	optional, power rating see page 16
Temperature sensor:	optional, power rating see page 16
Pressure:	max. 1 bar
Operating temperature:	-20°C to 100°C in medium, -15°C to 70°C above mounting
Protection rating:	IP 65

Data sheet / product information

Mini float switch M60...02.27.8 / M60...08.27.8

in stainless steel with plug-type connector M12 4-pole / 5-pole mounting 1/2"

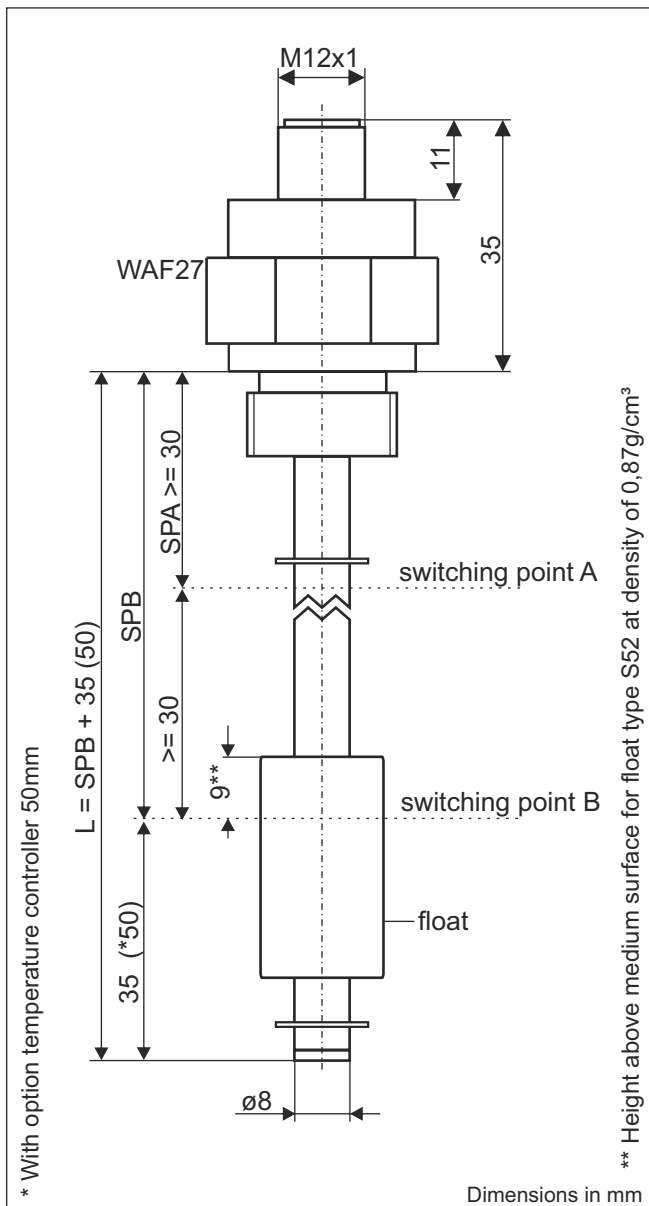

Terminal diagrams

M12 4pole (02)

Note: contacts are as normally open or normally closed possible!

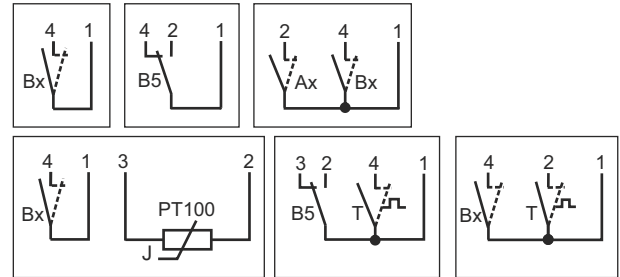

M12 5pole (08)

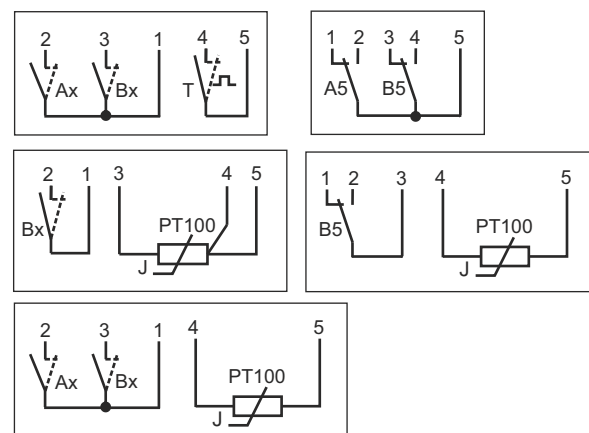

[Back to product group](#)

Technical data:

Connection:	plug-type connector M12x1 4- and 5 -pole, material TPU
Mounting:	thread 1/2", material stainless steel
Mounting position:	vertical $\pm 10^\circ$
Tube:	$\varnothing 8$ mm material stainless steel, material and length acc. customer specification
Float:	$\varnothing 17,8 \times 32$ mm, material NBR, type S52
Reed contact:	max. 2x reed contacts n.o. contacts / n.c. contacts or 2x change over contacts, function bistabile
Switching voltage:	max. 24VDC
Switching current:	150mA
Temperature switching:	optional, power rating see page 16
Temperature sensor:	optional, power rating see page 16
Pressure:	max. 1 bar
Operating temperature:	-20°C to 100°C in medium, -15°C to 70°C above mounting
Protection rating:	IP 65

Subject to change