

**Technical specification**

		<b>9B4</b>	<b>9K4</b>	<b>9M4</b>
Ambient temperature:	Standard:	-25°C ... +85°C	-25°C ... + 85°C	0°C ... +80°C
	with sensor 789/790/791:	-40°C ... +85°C		
Media temperature:	Standard:	-25°C ... +125°C	-25°C ... + 125°C	0°C ... +80°C
	with sensor 789/790/791:	-40°C ... +125°C		

**Type label description**



Serial number → S/N : YYYYYYYY-ZZZ 16/11 ← Manufacturing date (W/Y)

Type code → Type : XXX.XXXX IP65 ← Ingress Protection

Measuring range → Range : X...XX bar (~kg/cm<sup>2</sup>)  
X...XX MPa ← Operating temperature

Max. overpressure → p-max : XX bar / XX MPa

Switching rating → 250 V AC 6(1)A 24V DC 3(2)A

**Switching differential (typ.) [bar] fixed value, not adjustable**

Bellows sensor 9B4	[bar] [psi]	Range						
		-0.6...3.4 -8...45	0.4 0.50	0.6 0...100	1...16 14...150	1...16 14...250	2...25 30...400	4...40 60...500
Microswitch 42/33/84	[bar] [psi]	0.2 ± 0.1 4.5	0.2 ± 0.1 4.5	0.2 ± 0.1 4.5	0.4 ± 0.2 9	0.4 ± 0.2 9	1.0 ± 0.6 22	1.2 ± 0.8 26
P max.	[bar]	12	12	12	24	24	40	50
	[psi]	174	174	174	348	348	580	725

Piston sensor 9K4	[bar] [psi]	Range								
		1...16 14...150	1...16 14...250	2...25 30...400	4...40 60...500	6...60 85...850	10...100 150...1500	16...160 250...2500	25...250 350...3500	40...400 580...5800
Microswitch 42/33/84	[bar] [psi]	0.4 ... 2.4 6...35	0.4 ... 2.4 6...35	1 ... 6 14.5...88	1 ... 6 14.5...88	5 ... 15 73...218	5 ... 15 73...218	12 ... 40 174...580	12 ... 40 174...580	15 ... 50 218...725

Membrane sensor 9M4	[bar] [psi]	Range					
		1...16 14...150	1...16 14...250	2...25 30...400	4...40 60...500	6...60 85...850	10...100 150...1500
Microswitch 42/33/84	[bar] [psi]	0.2 ... 1.7 3...24.5	0.2 ... 1.7 3...24.5	1.2 ... 4.5 18...66	1.2 ... 4.5 18...66	4 ... 16 58...232	4 ... 16 58...232

**Electrical connections**

Type	Features	Rating <sup>1)</sup>		
		AC	DC	
Standard	Silver contacts	250 V	6 (1)A	220 V 0.25 (0.1) A
				110 V 0.5 (0.2) A
				60 V 1(0.5) A
				24 V 3(2) A
				12 V 6(6) A
84	Gold plated contacts, suitable for intrinsically safe control circuits	max. 30 V 0.1 (0.1) A min. 5 V 5 mA		

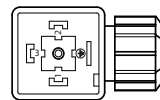

EN175301-803-A

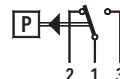

<sup>1)</sup> Resistive Load (Inductive Load)

## Dimensions

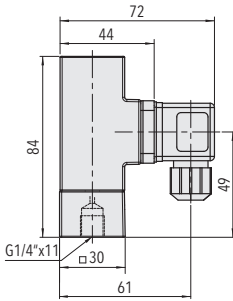

9X4.XXXX.7XX.04[46]V3

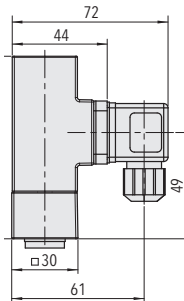
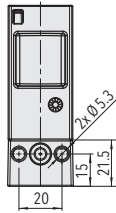

9X4.XXXX.7XX.04[11]46.74.V3

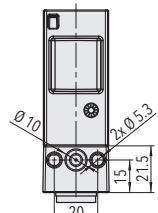

## Pressure connection

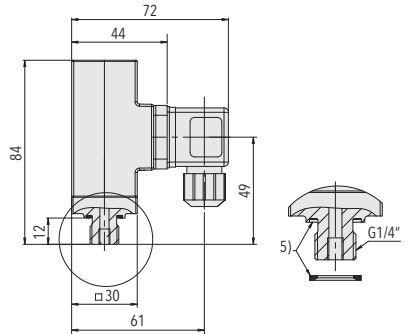
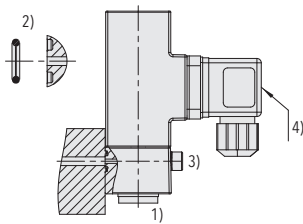
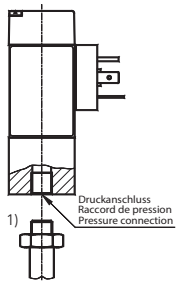

- 1) Torque: G 1/4":  $M_A = 32 \dots 40 \text{ Nm}$
- 2) O-ring:  $\varnothing 6.75 \times 1.78$   
 $\geq 250 \text{ bar NBR 90 Shore}$   
 $< 250 \text{ bar NBR 75 Shore}$

- 3) Fastening screw: M5  
 Property class: 8.8  
 Mounting torque:  $4.5 \dots 6 \text{ Nm}$

- 4) Torque connector center screw:  $\text{max. } 0.4 \text{ Nm}$
- 5) Seal: see accessories in the datasheet [www.trafag.com/H72367](http://www.trafag.com/H72367)

## Switching point adjustment

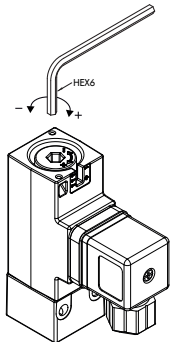

H: Hysteresis depending on the preset value.

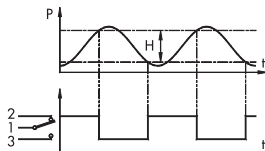

## Attention

