

# PICOSTAT PRESSURE SWITCH

Swiss based Trafag is a leading international supplier of high quality sensors and monitoring instruments for measurement of pressure and temperature. The 9B4 of the Picostat series is based on our long lasting experience in the shipbuilding and railway sector. This further improved version offers high vibration resistance within a compact body and is suitable for a wide temperature range.



## Applications

- Shipbuilding
- Engine manufacturing
- Railways
- Machine tools



## Features

- Improved vibration resistance
- Compact design
- Rugged housing
- Protection IP65
- Any mounting position possible









Technical Data			
Measuring principle	Bellows	Repeatability	± 0.5 % FS typ.
Measuring range	-0.6 ... 3.4 to 4 ... 40 bar -8 ... 45 to 60 ... 500 psi	Media temperature	Standard: -25°C ... +125°C with sensor 789/790/791: -40°C ... +125°C
Output signal	1 Floating change-over contact (SPDT)	Ambient temperature	Standard: -25°C ... +85°C with sensor 789/790/791: -40°C ... +85°C
Switching differential	Not adjustable	Approval / conformity	ABS, BV, CCS, DNV-GL, KRS, LR, NKK, RINA, RMRS EN60730-1/ EN60730-2-6: Type 2.B.H

09/2024

Data sheet H72367q

Subject to change

## Ordering information/type code

				9B4 .	XX	XX	XXX	XX	XX
<b>Microswitch</b>	Standard <sup>1)</sup>				42				
	Standard  <sup>1)</sup>				33				
	Gold plated contacts <sup>1)</sup>				84				
<b>Range</b>	<b>Range [bar]</b>	<b>Over pressure [bar]</b>		<b>Range [psi]</b>	<b>Over pressure [psi]</b>				
	-0.6 ... 3.4	12	<b>74</b>	-8 ... 45	174		<b>G4</b>		
	0 ... 4	12	<b>76</b>	0 ... 50	174		<b>G6</b>		
	0 ... 6	12	<b>77</b>	0 ... 100	174		<b>G7</b>		
	1 ... 10	24	<b>78</b>	14 ... 150	348		<b>G8</b>		
	1 ... 16	24	<b>79</b>	14 ... 250	348		<b>G9</b>		
	2 ... 25	40	<b>80</b>	30 ... 400	580		<b>H0</b>		
	4 ... 40	50	<b>81</b>	60 ... 500	725		<b>H1</b>		
<b>Sensor</b>	<b>Sensor material</b>	<b>Sensor housing material</b>		<b>Range</b>					
	Bronze bellows (CuSn6)  <sup>2)</sup>	Aluminium EN AW-6026 AlMgSiPb0.4 anodized		74			<b>769</b>		
	Bronze bellows (CuSn6)  <sup>2)</sup>	Aluminium EN AW-6026 AlMgSiPb0.4 anodized		76, 77			<b>770</b>		
	Bronze bellows (CuSn6)  <sup>2)</sup>	Aluminium EN AW-6026 AlMgSiPb0.4 anodized		78, 79			<b>771</b>		
	Bronze bellows (CuSn6)  <sup>2)</sup>	Aluminium EN AW-6026 AlMgSiPb0.4 anodized		80, 81			<b>772</b>		
	Bronze bellows (CuSn6)  <sup>3) 4)</sup>	Brass (CuZn39Pb3)		74			<b>789</b>		
	Bronze bellows (CuSn6)  <sup>3) 4)</sup>	Brass (CuZn39Pb3)		76, 77			<b>790</b>		
	Bronze bellows (CuSn6)  <sup>3) 4)</sup>	Brass (CuZn39Pb3)		78, 79			<b>791</b>		
	Bellows stainless steel (1.4404/AISI316L) <sup>4)</sup>	Stainless steel		76, 77			<b>753</b>		
Bellows stainless steel (1.4404/AISI316L) <sup>4)</sup>	Stainless steel		78, 79			<b>754</b>			
<b>Pressure connection</b>	G1/8" female								<b>02</b>
	G1/4" female								<b>04</b>
	M10x1 female <sup>5)</sup>								<b>03</b>
	G1/4" male <sup>5)</sup>								<b>17</b>
<b>Accessories</b>	Flange with O-Ring <sup>4)</sup>								<b>11</b>
	Female electrical plug EN 175301-803-A (DIN 43650-A)								<b>46</b>
	Welsh plug G1/4"								<b>74</b>
	Fixing set								<b>V3</b>
	Covering cap								<b>15</b>
	Lead seal (manipulation protection)								<b>16</b>
	Seal HNBR, -25°C ... +125°C (standard seal) <sup>6)</sup>								<b>83</b>
	Seal FKM, -18°C ... +125°C <sup>5)</sup>								<b>61</b>
	Seal EPDM, -40°C ... +125°C <sup>5)</sup>								<b>63</b>
	Switch point adjustment on customers request Please indicate when ordering: - Switchpoint including measurement unit (kPa, bar, MPa, psi, abs. or rel.) - Increasing or decreasing								<b>88</b>
	Switch point scale								<b>98</b>
	Damping elements and snubber see data sheet H72258								

<sup>1)</sup> Switching differential not adjustable

<sup>2)</sup> Media contacting O-Ring

<sup>3)</sup> O-Ring not media contacting

<sup>4)</sup> Only with pressure connection 04 (G1/4") others upon request

<sup>5)</sup> Upon request

<sup>6)</sup> For pressure connection G1/4" male upon request

## Standard products (extra short lead time)

Product No.	Type Code	Pressure range [bar]	Over pressure max. [bar]	Switching differential [bar]
PST4B3.44	9B4 4274 769 04 0000 0000 15 46 V3	-0.6 ... 3.4	12	0.2 ± 0.1 (fixed)
PST4B64	9B4 4277 770 04 0000 0000 15 46 V3	0 ... 6	12	0.2 ± 0.1 (fixed)
PST4B164	9B4 4279 771 04 0000 0000 15 46 V3	1 ... 16	24	0.4 ± 0.2 (fixed)
PST4B254	9B4 4280 772 04 0000 0000 15 46 V3	2 ... 25	40	1.0 ± 0.6 (fixed)
PST4B404	9B4 4281 772 04 0000 0000 15 46 V3	4 ... 40	50	1.2 ± 0.8 (fixed)
PST4B3.4F4	9B4 4274 769 04 0000 0000 11 15 46 74 V3	-0.6 ... 3.4	12	0.2 ± 0.1 (fixed)
PST4B6F4	9B4 4277 770 04 0000 0000 11 15 46 74 V3	0 ... 6	12	0.2 ± 0.1 (fixed)
PST4B16F4	9B4 4279 771 04 0000 0000 11 15 46 74 V3	1 ... 16	24	0.4 ± 0.2 (fixed)
PST4B25F4	9B4 4280 772 04 0000 0000 11 15 46 74 V3	2 ... 25	40	1.0 ± 0.6 (fixed)
PST4B40F4	9B4 4281 772 04 0000 0000 11 15 46 74 V3	4 ... 40	50	1.2 ± 0.8 (fixed)
PST4B6S4	9B4 4277 753 04 0000 0000 15 46 V3	0 ... 6	12	0.2 ± 0.1 (fixed)
PST4B16S4	9B4 4279 754 04 0000 0000 15 46 V3	1 ... 16	24	0.4 ± 0.2 (fixed)

Specifications		
<b>Accuracy</b>	Repeatability	± 0.5 % FS typ.
	Switching differential	See table
	Adjustment range switch point <sup>2)</sup>	10 % ... 90 % FS
	Temperature dependence switching point	-25°C ... +125°C: ca. -0.1% FS/°C typ. < -25°C: ca. -0.25% FS/°C typ.
<b>Environmental conditions</b>	Ambient temperature	Standard: -25°C ... +85°C with sensor 789/790/791: -40°C ... +85°C
	Media temperature	Standard: -25°C ... +125°C with sensor 789/790/791: -40°C ... +125°C
	Storage temperature	Standard: -30°C ... +125°C with sensor 789/790/791: -45°C ... +125°C
	Protection <sup>1)</sup>	IP65
	Humidity	Max. 95 % relative
	Vibration	Switch: IEC/EN 60068-2-6 10...59 Hz: ±0.75 mm Ampl. 59...500 Hz: 5 g
	Shock	50 g / 3 ms
<b>Mechanical data</b>	Sensor	See ordering information
	Housing	Aluminium EN AW-6026 AlMgSiPb0.4 anodized
	Sealing	HNBR 75 Sh, FKM, EPDM
	Housing seal	EPDM 75 Sh
	Male electrical connector	Polyamide (PA)
	Mounting torque	G 1/4": M <sub>A</sub> = 32 ... 40 Nm
	Installation	any position
	Weight	~ 160 g
<b>Microswitch</b>	Rating	See table
	Resistance of insulation	500 VDC > 10 MΩ
	Dielectric strength	> 1.5 kV AC/60 s terminal ground > 500 VAC/60 s via open contacts
<b>Electrical connection</b>	Electrical connections	EN175301-803-A (DIN43650-A)
	Female electrical connector	Cable-Ø: 4 ... 9 mm Terminal screw: 4 x 0.5...1.5 mm <sup>2</sup>

<sup>1)</sup> Provided female connector is mounted according to instructions

<sup>2)</sup> Other adjustment ranges upon request

## Dimensions

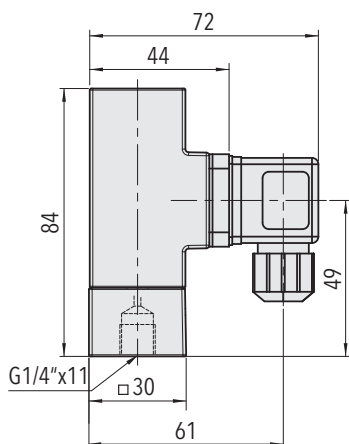

9B4.XXXX.7XX.04.46.V3

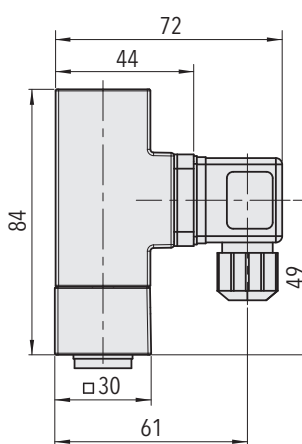
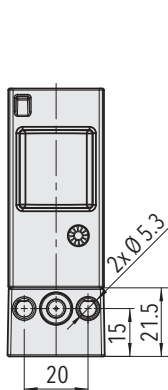

9B4.XXXX.7XX.04.11.46.74.V3

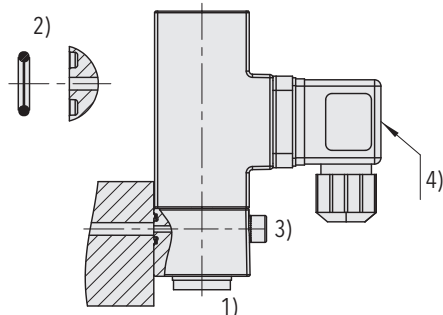
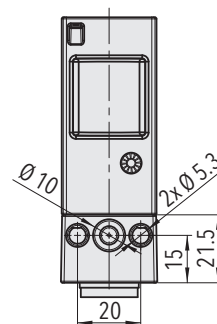

9B4.XXXX.XXX.XX.11

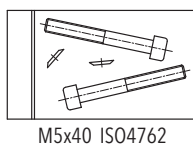

9B4.XXXX.XXX.XX.V3

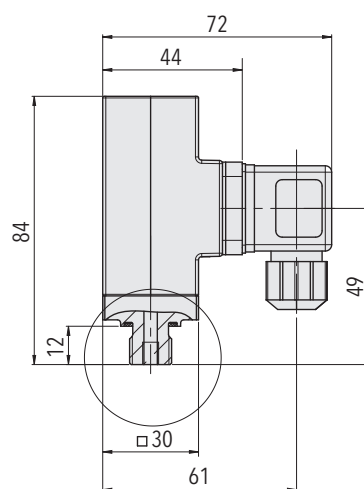

9B4.XXXX.7XX.17.XX

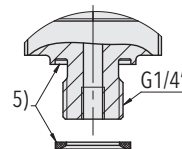

- 1) Torque: G 1/4":  $M_A = 32 \dots 40 \text{ Nm}$
- 2) O-Ring:  $\varnothing 6.75 \times 1.78$  NBR 90 Sh
- 3) Fixing screw: M5; property class: 8.8; torque:  $4.5 \dots 6 \text{ Nm}$
- 4) Torque connector center screw: max.  $0.4 \text{ Nm}$
- 5) Seal: see accessories

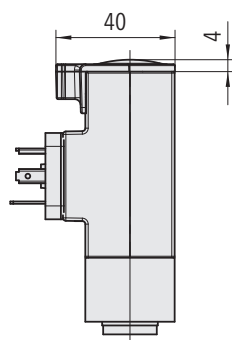

9B4.XXXX.XXX.XX.15

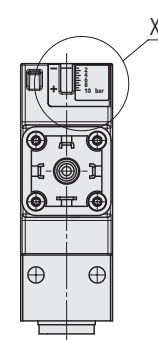
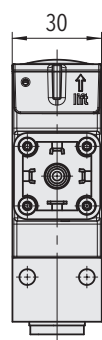

9B4.XXXX.XXX.XX.98

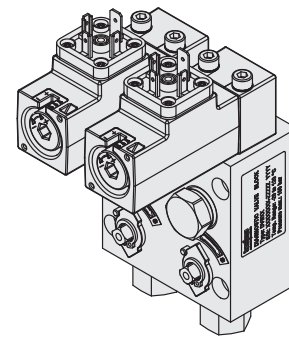
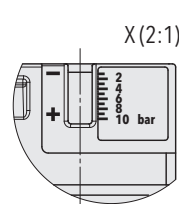

Diagnostic Valve Bloc (DVB)  
see specification sheet H72361

## Switching differential typ. @ 25°C

Measuring range	[bar]	-0.6 ... 3.4	0 ... 4	0 ... 6	1 ... 10	1 ... 16	2 ... 25	4 ... 40
<b>bellows sensor</b>	[psi]	-8 ... 45	0 ... 50	0 ... 100	14 ... 150	14 ... 250	30 ... 400	60 ... 500
<b>Microswitch 42/84/33:</b>	[bar]	0.2 ± 0.1	0.2 ± 0.1	0.2 ± 0.1	0.4 ± 0.2	0.4 ± 0.2	1.0 ± 0.6	1.2 ± 0.8
Switching differential not adjustable	[psi]	4.5	4.5	4.5	9	9	22	26

## Electrical data switch

Type	Features	Rating	
		AC	DC
<b>42/33</b> (Standard)	Silver contacts	250 V, 6 (1) A	220 V, 0.25 (0.1) A 110 V, 0.5 (0.2) A 60 V, 1(0.5) A 24 V, 3 (2) A 12 V, 6 (6) A
<b>84</b>	Gold plated contacts, suitable for intrinsically safe control circuits	max. 30 V, 0.1 (0.1) A min. 5 V, 5 mA	

## Electrical connection

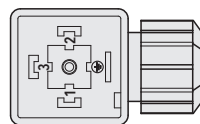
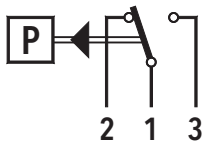

EN175301-803-A

## Additional information

<b>Documents</b>	Data sheet	<a href="http://www.trafag.com/H72367">www.trafag.com/H72367</a>
	Instructions	<a href="http://www.trafag.com/H73367">www.trafag.com/H73367</a>