

# INDUSTRIAL PRESSURE TRANSMITTER

Swiss based Trafag is a leading international supplier of high quality sensors and monitoring instruments for measurement of pressure and temperature. The industrial pressure transmitter NAT 8252 features an exceptionally long-term stable thin-film-on-steel sensor cell with triple (optionally 5-fold) overpressure safety. Optionally, the NAT 8252 is available as a pressure switch with 1 or 2 switching outputs. The robust design and the wide temperature range from -40°C to +125°C qualify the NAT 8252 as the ideal solution for a wide range of demanding applications.



## Applications

- Machine tools
- Hydraulics
- HVAC
- Refrigeration
- Process technology
- Water treatment

## Features

- Smallest design
- Completely welded steel sensor system without additional seals
- Excellent long-term stability
- Optional: 5-fold overpressure resistance
- Optional: Switching output 1 or 2 PNP

06/2024

Data sheet H72303ah

Technical Data			
Measuring principle	Thin-film-on-steel	Accuracy @ 25°C typ.	± 0.5 % FS typ.
Measuring range	0 ... 2.5 to 0 ... 700 bar 0 ... 30 to 0 ... 10000 psi	Media temperature	-40°C ... +125°C
Output signal	4 ... 20 mA, 0 ... 5 VDC, 1 ... 5 VDC, 1 ... 6 VDC, 0 ... 10 VDC and more, 0.5 ... 4.5 VDC ratiometric, Switching output: 1 or 2 PNP	Ambient temperature	max. -40°C ... + 125°C (UL-rated ambient temperature: -20°C ... +80°C) details see section Electrical Connection
NLH @ 25°C (BSL) typ.	± 0.2 % FS typ.		

Subject to change



<b>Electrical connection</b>	Male electrical connector, industrial standard, contact distance 9.4 mm, Mat. PA, EN 175301-803C	01
	Male electrical connector M12x1, 4-pole, Mat. PA, IEC 61076-2-101	32
	Male electrical connector M12x1, 5-pole, Mat. PA, IEC 61076-2-101	35
	Male electrical connector MIL-C 26482, 6-pole, metal	02
	Male electrical connector Deutsch DT04-3P, 3-pole	D3
	Male electrical connector Deutsch DT04-4P, 4-pole	D4
	Cable Mat. PVC, IP67/IP68, 2 x 2 x 0.14 mm <sup>2</sup> , max. traction on cable: 2 N <sup>7)</sup>	22
	Cable Mat. PUR, IP67/IP68, 4 x 0.25 mm <sup>2</sup> , shielded <sup>7)</sup>	24
	Cable Mat. EPD Raychem FDR25, IP67, 4 x 0.2 mm <sup>2</sup> , shielded <sup>7)</sup>	08
	Cable Mat. Radox Tenuis, IP67/IP68, 4 x 0.5 mm <sup>2</sup> , shielded <sup>7)</sup>	88
	Compact design: Cable Mat. PVC, IP40, 2 x 2 x 0.14 mm <sup>2</sup> , shielded, max. traction on cable: 2 N <sup>9) 16) 17)</sup>	A1
	JST (or compatible) Board to Cable/Wire Disconnectable Crimp style connector, BM04B-SRSS-TB, IP20, 4-pole <sup>9) 17)</sup>	J4

<b>Output signal</b>	Signal output	Load resistance	I (supply)	U (supply)	
	4 ... 20 mA	See graphic		(= signal output)	24 (9 ... 32) VDC
0.5 ... 4.5 VDC <sup>4)</sup>	≥ 5.0 kΩ to Us-	≤ 20 mA		24 (9 ... 32) VDC	20
0 ... 5 VDC	≥ 5.0 kΩ to Us-	≤ 20 mA		24 (9 ... 32) VDC	14
0.1 ... 4.1 VDC <sup>4)</sup>	≥ 5.0 kΩ to Us-	≤ 20 mA		24 (9 ... 32) VDC	28
0.1 ... 5.1 VDC <sup>4)</sup>	≥ 5.0 kΩ to Us-	≤ 20 mA		24 (9 ... 32) VDC	29
0.5 ... 5 VDC <sup>4)</sup>	≥ 5.0 kΩ to Us-	≤ 20 mA		24 (9 ... 32) VDC	22
1 ... 5 VDC <sup>4)</sup>	≥ 5.0 kΩ to Us-	≤ 20 mA		24 (9 ... 32) VDC	25
0.5 ... 5.5 VDC <sup>4)</sup>	≥ 5.0 kΩ to Us-	≤ 20 mA		24 (9 ... 32) VDC	24
1 ... 6 VDC	≥ 5.0 kΩ to Us-	≤ 20 mA		24 (9 ... 32) VDC	16
0 ... 10 VDC	≥ 5.0 kΩ to Us-	≤ 15 mA		24 (15 ... 32) VDC	17
1 ... 10 VDC	≥ 5.0 kΩ to Us-	≤ 15 mA		24 (15 ... 32) VDC	26
0.1 ... 10.1 VDC	≥ 5.0 kΩ to Us-	≤ 15 mA		24 (15 ... 32) VDC	13
0.5 ... 4.5 VDC ratiometric	≥ 5.0 kΩ to Us-	≤ 10 mA		5 (4.75 ... 5.25) VDC	23
2 PNP transistors <sup>3)</sup>		≤ 10 mA		24 (9 ... 32) VDC	PS
1 PNP transistor <sup>10)</sup>		≤ 10 mA		24 (9 ... 32) VDC	T1

<b>Accessories</b>	Female electrical plug M12x1, 5-pole <sup>2)</sup>	33
	Female electrical plug industrial standard (for electrical connection 01), EN 175301-803C	34
	Pressure peak damping element ø 1.0 mm <sup>4)</sup>	40
	Pressure peak damping element ø 0.4 mm <sup>4)</sup>	44
	Seal FKM, -18°C ... +125°C	61
	Seal EPDM, -40°C ... +125°C	63
	Seal NBR, -25°C ... +100°C	83
	Special electrical connection: Pin 2 +, Pin 3 Ground, Pin 4 - (only for output signal 19 and male electrical connector 01, industrial standard)	90
	Special electrical connection: Pin 1 Out, Pin 2 +, Pin 3 Ground, Pin 4 - (only for output signals 13, 14, 16, 17, 20, 22, 23, 24, 25, 26, 28, 29 and male electrical connector 01, industrial standard)	91
	Special electrical connection: Pin 1 +, Pin 2 Ground, Pin 3 Out, Pin 4 - (only for output signals 13, 14, 16, 17, 20, 22, 23, 24, 25, 26, 28, 29 and male electrical connector 32, M12x1, 4-pole)	95
	Special electrical connection: Pin 1 +, Pin 2 Ground, Pin 3 -, Pin 4 Out (only for output signals 13, 14, 16, 17, 20, 22, 23, 24, 25, 26, 28, 29 and male electrical connector 32, M12x1, 4-pole)	96
	Special electrical connection: Pin 1 +, Pin 3 -, Pin 4 Out (only for output signals 13, 14, 16, 17, 20, 22, 23, 24, 25, 26, 28, 29 and male electrical connector 32, M12x1, 4-pole)	G1
	Special electrical connection: Pin 1 +, Pin 2 -, Pin 4 Ground (only for output signal 19 and male electrical connector 01, industrial standard)	92
	Special electrical connection: Pin 1 +, Pin 2 -, Pin 4 Ground (only for output signal 19 and male electrical connector 32, M12x1, 4-pole)	E1
	Special electrical connection: Pin 1 +, Pin 2 -, Pin 3 Out, Pin 4 Ground (only for output signals 13, 14, 16, 17, 20, 22, 23, 24, 25, 26, 28, 29 and male electrical connector 32, M12x1, 4-pole)	E2
	Special electrical connection: Pin 1 Out, Pin 2 -, Pin 3 +, Pin 4 Ground (only for output signals 13, 14, 16, 17, 20, 22, 23, 24, 25, 26, 28, 29 and male electrical connector 01, industrial standard)	E3
	Special electrical connection: Pin 1 +, Pin 2 -, Pin 3 Out, Pin 4 Ground (only for output signals 13, 14, 16, 17, 20, 22, 23, 24, 25, 26, 28, 29 and male electrical connector 01, industrial standard)	E9
	Special electrical connection: Pin 1 +, Pin 2 Ground, Pin 4 - (only for output signal 19 and male electrical connector 32, M12x1, 4-pole)	E6
	Special electrical connection: Pin A +, Pin C - (only for output signal 19 and male electrical connector Deutsch DT04-3P, 3-pole)	F0
	Special electrical connection: Pin A +, Pin B Out, Pin C - (only for output signals 13, 14, 16, 17, 20, 22, 23, 24, 25, 26, 28, 29 and male electrical connector Deutsch DT04-3P, 3-pole)	F1
	Special electrical connection: Pin 2 +, Pin 3 - (only for output signals 19 and male electrical connector Deutsch DT04-4P, 4-pole)	G3
	Special electrical connection: Pin 1 Out, Pin 2 +, Pin 3 - (only for output signals 13, 14, 16, 17, 20, 22, 23, 24, 25, 26, 28, 29 and male electrical connector Deutsch DT04-4P, 4-pole)	G4
	Special electrical connection: Pin A +, Pin C Out, Pin B/D -, Pin E Ground (Pin B and D are connected) (only for output signals 13, 14, 16, 17, 20, 22, 23, 24, 25, 26, 28, 29 and male electrical connector 02, MIL-C 26482)	F3
	Special electrical connection: Pin 1 +, Pin 2 - (only for output signal 19 and male electrical connector 32, M12x1, 4-pole)	F4
	Special electrical connection: Pin 1 +, Pin 3 - (only for output signal 19 and male electrical connector 32, M12x1, 4-pole)	F5
	Special electrical connection: Pin 1 +, Pin 2 -, Pin 3 -, Pin 4 Ground (only for output signals 19 and male electrical connector 32, M12x1, 4-pole)	G2
	Special electrical connection: Pin 1 +, Pin 4 - (only for output signals 19 and male electrical connector 32, M12x1, 4-pole)	G5
	Special electrical connection: Pin 2 -, Pin 3 +, Pin 4 Ground (only for output signals 19 and male electrical connector 32, M12x1, 4-pole)	G8
	Special electrical connection: Pin 1 +, Pin 2 Out, Pin 3 Ground, Pin 4 - (only for output signals 13, 14, 16, 17, 20, 22, 23, 24, 25, 26, 28, 29 and male electrical connector 32, M12x1, 4-pole)	F6
	Special electrical connection: Pin 1 +, Pin 2 Out, Pin 3 - (only for output signals 13, 14, 16, 17, 20, 22, 23, 24, 25, 26, 28, 29 and male electrical connector 32, M12x1, 4-pole)	F7
	Cable length 0.5 m	EM
	Cable length 1.0 m	1M
	Cable length 2.0 m	2M
	Parametrisation according to customer specification for output signal PS, T1 (see table "Parameters")	ZC
	Parametrisation standard for output signal PS, T1 (see table "Parameters")	ZS
	Multiple packaging <sup>8)</sup>	VM
	UL-listed version <sup>13)</sup>	UL

<sup>1)</sup> Customized pressure ranges upon request

<sup>2)</sup> For electrical connections 32 and 35

<sup>3)</sup> Only with electrical connections 32, 22, 24, 08, 88

<sup>4)</sup> Max. allowable pressure range 60 bar (870 psi) at 180 bar (2610 psi) overpressure

<sup>5)</sup> Max. allowable pressure range 160 bar (2320 psi) at 480 bar (6961 psi) overpressure

<sup>6)</sup> Not for pressure connections 53, 24, 44, 18

<sup>7)</sup> Cable length see accessories

<sup>8)</sup> The order quantity must be a multiple of 50, only for electrical connections 01, 32, 35, 02, D3, D4, not for pressure connection 30 with electrical connections 02, D3, D4

<sup>9)</sup> Upon request

<sup>10)</sup> Only with electrical connections 32, 22, 24, 08, 88, D3

<sup>11)</sup> Without seal, use seal geometry according DIN EN ISO 6149-2

<sup>12)</sup> Max. allowable pressure range 400 bar (5800 psi) at 600 bar (8700 psi) overpressure

<sup>13)</sup> Possible type code combinations for UL-listed versions see separate table

<sup>14)</sup> Measuring range max. 630 bar according to SAE J1926-2 (Heavy Duty)

<sup>15)</sup> For measuring ranges  $\geq 2$  bar

<sup>16)</sup> Cable length 2m only, with accessory 2M

<sup>17)</sup> Not UL-listed

## Standard products (extra short lead time)

Product No.	Type Code	Pressure range [bar]	Over pressure max. [bar]	Supply [VDC]	Accuracy @ 25°C typ. [%]
NAT2.5A	8252 75 2517 01 0000 0000 19 34 44 61	0 ... 2.5	7.5	9 ... 32	±0.5
NAT4.0A	8252 76 2517 01 0000 0000 19 34 44 61	0 ... 4	12	9 ... 32	±0.5
NAT6.0A	8252 77 2517 01 0000 0000 19 34 44 61	0 ... 6	18	9...32	±0.5
NAT10.0A	8252 78 2517 01 0000 0000 19 34 44 61	0 ... 10	30	9...32	±0.5
NAT16.0A	8252 79 2517 01 0000 0000 19 34 44 61	0 ... 16	48	9 ... 32	±0.5
NAT25.0A	8252 80 2517 01 0000 0000 19 34 44 61	0 ... 25	75	9 ... 32	±0.5
NAT40.0A	8252 81 2517 01 0000 0000 19 34 44 61	0 ... 40	120	9 ... 32	±0.5
NAT60.0A	8252 82 2517 01 0000 0000 19 34 44 61	0 ... 60	180	9 ... 32	±0.5
NAT100.0A	8252 83 2517 01 0000 0000 19 34 44 61	0 ... 100	300	9 ... 32	±0.5
NAT250.0A	8252 74 2517 01 0000 0000 19 34 44 61	0 ... 250	750	9 ... 32	±0.5
NAT400.0A	8252 84 2517 01 0000 0000 19 34 44 61	0 ... 400	1000	9 ... 32	±0.5
NAT600.0A	8252 86 2517 01 0000 0000 19 34 44 61	0 ... 600	1500	9 ... 32	±0.5
NAT2.5V	8252 75 2517 01 0000 0000 17 34 44 61	0 ... 2.5	7.5	15 ... 32	±0.5
NAT4.0V	8252 76 2517 01 0000 0000 17 34 44 61	0 ... 4	12	15 ... 32	±0.5
NAT6.0V	8252 77 2517 01 0000 0000 17 34 44 61	0 ... 6	18	15 ... 32	±0.5
NAT10.0V	8252 78 2517 01 0000 0000 17 34 44 61	0 ... 10	30	15 ... 32	±0.5
NAT16.0V	8252 79 2517 01 0000 0000 17 34 44 61	0 ... 16	48	15 ... 32	±0.5
NAT25.0V	8252 80 2517 01 0000 0000 17 34 44 61	0 ... 25	75	15 ... 32	±0.5
NAT40.0V	8252 81 2517 01 0000 0000 17 34 44 61	0 ... 40	120	15 ... 32	±0.5
NAT60.0V	8252 82 2517 01 0000 0000 17 34 44 61	0 ... 60	180	9 ... 32	±0.5
NAT100.0V	8252 83 2517 01 0000 0000 17 34 44 61	0 ... 100	300	15 ... 32	±0.5
NAT250.0V	8252 74 2517 01 0000 0000 17 34 44 61	0 ... 250	750	15 ... 32	±0.5
NAT400.0V	8252 84 2517 01 0000 0000 17 34 44 61	0 ... 400	1000	15 ... 32	±0.5
NAT600.0V	8252 86 2517 01 0000 0000 17 34 44 61	0 ... 600	1500	15 ... 32	±0.5
NAT2.5AM	8252 75 2517 32 0000 0000 19 33 44 61	0 ... 2.5	7.5	9 ... 32	±0.5
NAT4.0AM	8252 76 2517 32 0000 0000 19 33 44 61	0 ... 4	12	9 ... 32	±0.5
NAT6.0AM	8252 77 2517 32 0000 0000 19 33 44 61	0 ... 6	18	9 ... 32	±0.5
NAT10.0AM	8252 78 2517 32 0000 0000 19 33 44 61	0 ... 10	30	9 ... 32	±0.5
NAT16.0AM	8252 79 2517 32 0000 0000 19 33 44 61	0 ... 16	48	9 ... 32	±0.5
NAT25.0AM	8252 80 2517 32 0000 0000 19 33 44 61	0 ... 25	75	9 ... 32	±0.5
NAT40.0AM	8252 81 2517 32 0000 0000 19 33 44 61	0 ... 40	120	9 ... 32	±0.5
NAT60.0AM	8252 82 2517 32 0000 0000 19 33 44 61	0 ... 60	180	9 ... 32	±0.5
NAT100.0AM	8252 83 2517 32 0000 0000 19 33 44 61	0 ... 100	300	9 ... 32	±0.5
NAT160.0AM	8252 85 2517 32 0000 0000 19 33 44 61	0 ... 160	480	9 ... 32	±0.5
NAT250.0AM	8252 74 2517 32 0000 0000 19 33 44 61	0 ... 250	750	9 ... 32	±0.5
NAT400.0AM	8252 84 2517 32 0000 0000 19 33 44 61	0 ... 400	1000	9 ... 32	±0.5
NAT600.0AM	8252 86 2517 32 0000 0000 19 33 44 61	0 ... 600	1500	9 ... 32	±0.5

## Standard products (extra short lead time)

Product No.	Type Code	Pressure range [bar]	Over pressure max. [bar]	Supply [VDC]	Accuracy @ 25°C typ. [%]
NAT2.5PS	8252 75 2517 32 0000 0000 PS 44 61 ZS	0 ... 2.5	7.5	9 ... 32	±0.5
NAT4.0PS	8252 76 2517 32 0000 0000 PS 44 61 ZS	0 ... 4	12	9 ... 32	±0.5
NAT6.0PS	8252 77 2517 32 0000 0000 PS 44 61 ZS	0 ... 6	18	9 ... 32	±0.5
NAT10.0PS	8252 78 2517 32 0000 0000 PS 44 61 ZS	0 ... 10	30	9 ... 32	±0.5
NAT16.0PS	8252 79 2517 32 0000 0000 PS 44 61 ZS	0 ... 16	48	9 ... 32	±0.5
NAT25.0PS	8252 80 2517 32 0000 0000 PS 44 61 ZS	0 ... 25	75	9 ... 32	±0.5
NAT40.0PS	8252 81 2517 32 0000 0000 PS 44 61 ZS	0 ... 40	120	9 ... 32	±0.5
NAT60.0PS	8252 82 2517 32 0000 0000 PS 44 61 ZS	0 ... 60	180	9 ... 32	±0.5
NAT100.0PS	8252 83 2517 32 0000 0000 PS 44 61 ZS	0 ... 100	300	9 ... 32	±0.5
NAT160.0PS	8252 85 2517 32 0000 0000 PS 44 61 ZS	0 ... 160	480	9 ... 32	±0.5
NAT250.0PS	8252 74 2517 32 0000 0000 PS 44 61 ZS	0 ... 250	750	9 ... 32	±0.5
NAT400.0PS	8252 84 2517 32 0000 0000 PS 44 61 ZS	0 ... 400	1000	9 ... 32	±0.5
NAT600.0PS	8252 86 2517 32 0000 0000 PS 44 61 ZS	0 ... 600	1500	9 ... 32	±0.5

## Ordering information: Possible type code combinations for UL-listed versions

	Combination with UL
Measuring range	all ranges ≤ 700 bar
Sensor	all codes on datasheet
Pressure connection	all codes on datasheet
Electrical connection	all codes except A1 and J4
Output signal	all codes except PS and T1
Accessories	all codes on datasheet

Parameters				
Name	Standard setting (accessory ZS)	Value range	Short name	Customer adjustment (accessory ZC)
Switch point SP1 (hysteresis mode) Upper switch point FH1 (window mode)	75 % Measuring range	> RP1, FL1 (2 ... 99 %) Hysteresis $\geq$ 1 % FS	SP1	
Reset point RP1 (hysteresis mode) Lower switch point FL1 (window mode)	25 % Measuring range	< SP1, FH1 (1 ... 98 %) Hysteresis $\geq$ 1 % FS	RP1	
Switch point SP2 (hysteresis mode) Upper switch point FH2 (window mode)	75 % Measuring range	> RP2, FL2 (2 ... 99 %) Hysteresis $\geq$ 1 % FS	SP2	
Reset point RP2 (hysteresis mode) Lower switch point FL2 (window mode)	25 % Measuring range	< SP2, FH2 (1 ... 98 %) Hysteresis $\geq$ 1 % FS	RP2	
Switch point delay time SP1 / RP1 (hysteresis mode) Switch point delay time FH1 / FL1 (window mode)	0	0; approx. 2 <sup>x</sup> [ms], x = 3, 4 ... 16	dS1	
Switch point delay time SP2 / RP2 (hysteresis mode) Switch point delay time FH2 / FL2 (window mode)	0	0; approx. 2 <sup>x</sup> [ms], x = 3, 4 ... 16	dS2	
Functions switching output 1	Hysteresis, closer (Hno)	Hysteresis NO (Hno), Hysteresis NC (Hnc) Window NO (Fno), Window NC (Fnc)	ou1	
Functions switching output 2	Hysteresis, closer (Hno)	Hysteresis NO (Hno), Hysteresis NC (Hnc) Window NO (Fno), Window NC (Fnc) Device ready	ou2	

## **i** Parameterization of switching points

The switching points, delay times and output functions can be parameterised quickly and easily with the Sensor Master Communicator (SMC) application, which is available for Windows (PC) and Android smartphone. The Android app is available in the Google Play Store and the Windows app is available in the Microsoft Store. The apps are free of charge.



- Data sheet SMI Sensor Master Interface: [www.trafag.com/H72618](http://www.trafag.com/H72618)
- Instruction for the Sensor Master Communicator App (SMC) and the Sensor Master Interface (SMI): [www.trafag.com/H73618](http://www.trafag.com/H73618)



Specifications		
<b>Electrical data</b>	Output / supply voltage	4 ... 20 mA: 24 (9...32) VDC 0 ... 6 VDC ranges: 24 (9...32) VDC 0 ... 10.1 VDC ranges: 24 (15...32) VDC 0.5 ... 4.5 VDC ratiom., 10 ... 90% $U_{supply}$ : $5 \pm 0.25$ VDC 1 or 2 PNP transistors: 24 (9...32) VDC
	Rise time	Typ. 1 ms / 10 ... 90 % nominal pressure
	Power-on delay time pressure transmitters	100 ms
	Power-on delay time pressure switches	50 ms + switching delay time
	Inverse-polarity protection, short-circuit strength @ 25°C during 5 min.	4...20 mA: to $U_s = 32$ VDC 0 ... 6 VDC ranges, 0 ... 10.1 VDC ranges: bis $U_s = 28$ VDC 0.5...4.5 VDC ratiometric: to $U_s = 14$ VDC 1 or 2 PNP transistors: to $U_s = 32$ VDC
<b>Environmental conditions</b>	Media temperature	-40°C ... +125°C
	Ambient temperature	max. -40°C ... + 125°C (UL-rated ambient temperature: -20°C ... +80°C) details see section Electrical Connection
	Protection	IP20, IP40, IP65, IP67, IP68 details see section Electrical Connection
	Humidity	Max. 95 % relative
	Vibration	15 g RMS (20...2000 Hz) (EN60068-2-64) 25 g sin (80...2000 Hz), 1 oct./min, (1x @ 25°C) (EN60068-2-6)
	Shock	50 g / 11 ms 100 g / 6 ms Male electrical plug M12x1 (EN60068-2-27) <sup>2)</sup>
<b>EMC protection</b> <sup>1)</sup>	Emission	EN/IEC 61000-6-3
	Immunity	EN/IEC 61000-6-2
<b>Mechanical data</b>	Sensor (wetted parts)	1.4542 (AISI630)
	Pressure connection (wetted parts)	1.4542 (AISI630)
	Housing	1.4301 (AISI304)
	Sealing	FPM/EPDM/NBR
	Male electrical connector	See ordering information
	Weight	appr. 50 g
	Mounting torque	25 Nm

<sup>1)</sup> Electrical connection J4 not EMC tested

<sup>2)</sup> For electrical connections 32 and 35



## Analogue output

Accuracy	TEB @ -25 ... +85°C	[% FS typ.]	± 1.75
	Accuracy @ +25°C	[% FS typ.]	± 0.5
	NLH @ +25°C (BSL)	[% FS typ.]	± 0.2
	TC zero point and span	[% FS/K typ.]	± 0.03
	Long term stability 1 year @ +25°C	[% FS typ.]	± 0.1
Rise time	Typ. 1 ms / 10 ... 90 % nominal pressure		

## Switching output

Accuracy	TEB @ -25 ... +85°C	[% FS typ.]	± 1.75
	Accuracy @ +25°C	[% FS typ.]	± 0.5
	Long term stability 1 year @ +25°C	[% FS typ.]	± 0.1
Setting range of switchpoints	1 ... 99 % FS		
Distance switch point	≥ 1.0 % FS		
Switch point > reset point	Switchpoint > reset point		
Switching resistance	≤ 3 Ω		
Output function	Hysteresis, Window; normally closed (NO), normally open (NC)		
Switching current	-40°C ... +85°C	(Ambient and media temperature)	≤ 400 mA, total of both switching outputs
	+85°C ... +125°C	(Ambient and media temperature)	≤ 200 mA, total of both switching outputs
Current limiting	integrated		
Life time	> 100 x 10 <sup>6</sup> cycles		
Delay time	0; approx. 2 <sup>x</sup> [ms], x = 3, 4 ... 16		
Switching frequency	max. 60 Hz (at switching delay time = 0)		

## Measuring accuracy

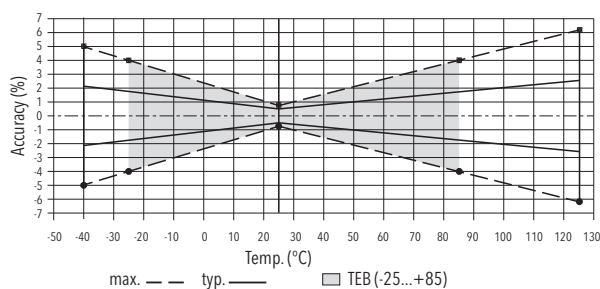

## Dimensions

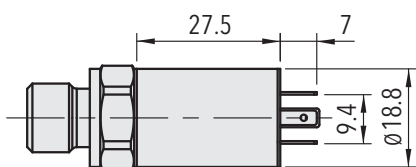

8252.XX.XXXX.01.XX.XX

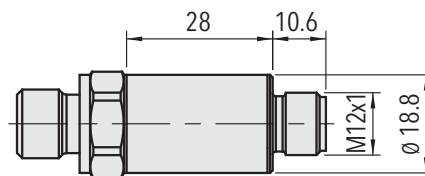

8252.XX.XXXX.32/35.XX.XX

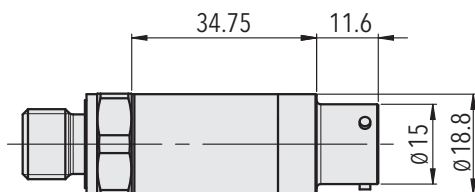

8252.XX.XXXX.02.XX.XX

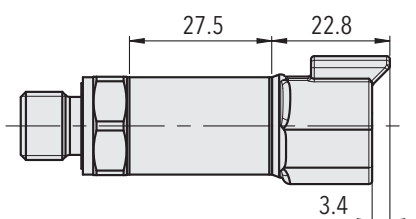

8252.XX.XXXX.D3.XX.XX

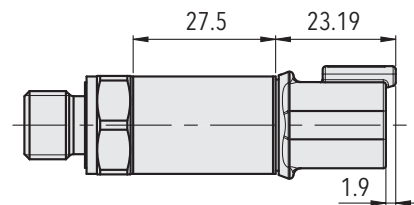

8252.XX.XXXX.D4.XX.XX

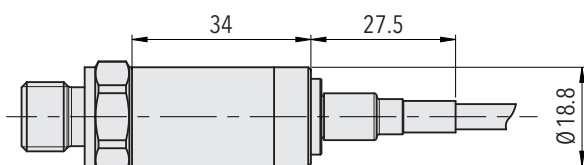

8252.XX.XXXX.08.XX.XX

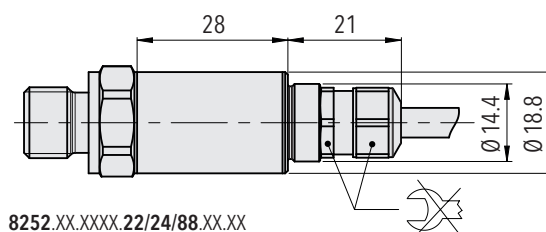

8252.XX.XXXX.22/24/88.XX.XX

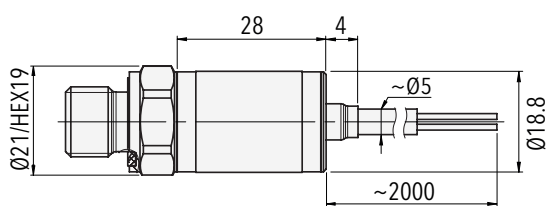

8252.XX.XXXX.A1.XX.XX

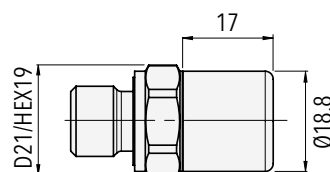

8252.XX.XXXX.J4.XX.XX

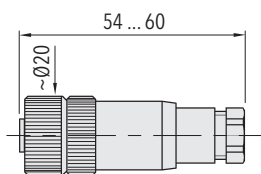

8252.XX.XXXX.XX.XX.33

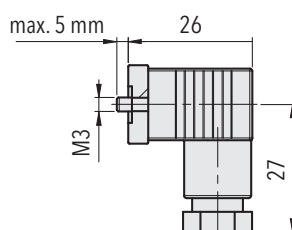

8252.XX.XXXX.XX.XX.34

## Dimensions

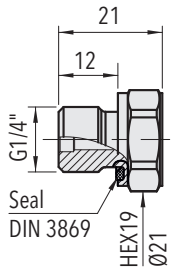

8252.XX.XX17.XX.XX.XX

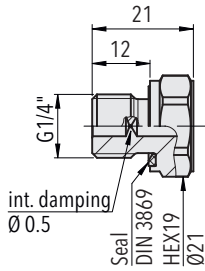

8252.XX.XX15.XX.XX.XX

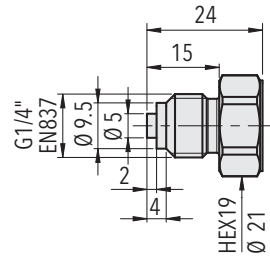

8252.XX.XX53.XX.XX.XX

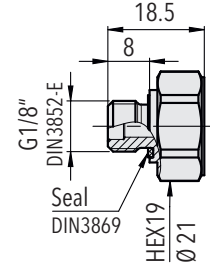

8252.XX.XX54.XX.XX.XX

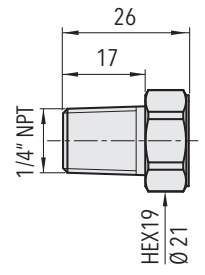

8252.XX.XX30.XX.XX.XX

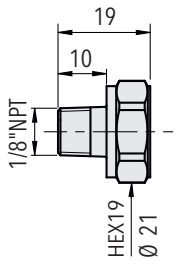

8252.XX.XX43.XX.XX.XX

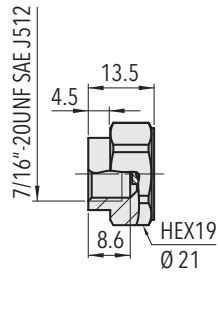

8252.XX.XX24.XX.XX.XX

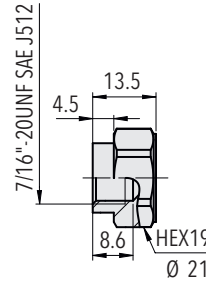

8252.XX.XX44.XX.XX.XX

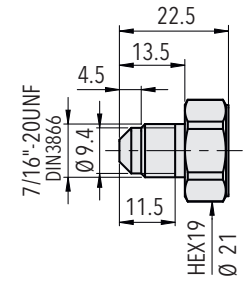

8252.XX.XX18.XX.XX.XX

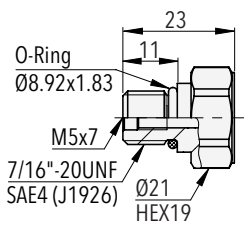

8252.XX.XX69.XX.XX.XX

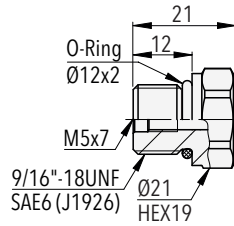

8252.XX.XX67.XX.XX.XX

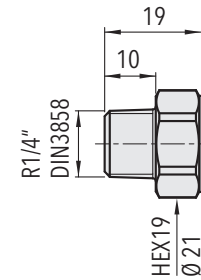

8252.XX.XX19.XX.XX.XX

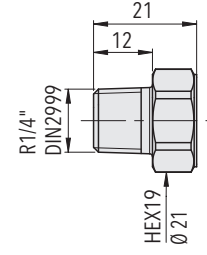

8252.XX.XX20.XX.XX.XX

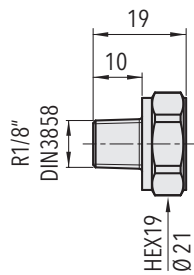

8252.XX.XX16.XX.XX.XX

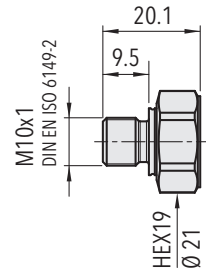

8252.XX.XX32.XX.XX.XX

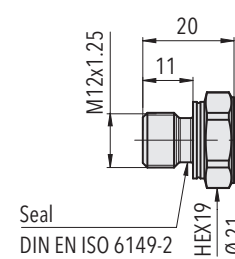

8252.XX.XX64.XX.XX.XX

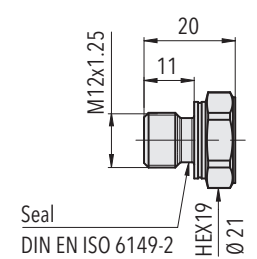

8252.XX.XX65.XX.XX.XX

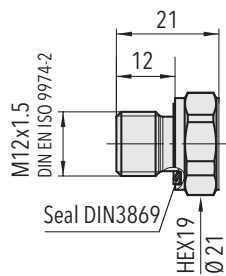

8252.XX.XX49.XX.XX.XX

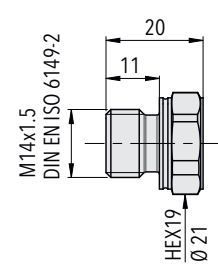

8252.XX.XX31.XX.XX.XX

## Electrical connection

		Protection / electrical connection																
		IP65 <sup>1) 2)</sup>			IP67 <sup>1) 2)</sup>					IP67 <sup>1) 2)</sup>		IP67, IP68 <sup>1) 3)</sup>		IP67, IP68 <sup>1) 3)</sup>				
Industrial standard					M12x1					MIL-C 26482		DT04-3P 3-pole		DT04-4P 4-pole				
Contact distance		9.4 mm			4-pole					5-pole								
		<b>01</b>			<b>32</b>					<b>35</b>		<b>02</b>		<b>D3</b>		<b>D4</b>		
Ambient temperature		-40°C ... +80°C			-40°C ... +125°C							-40°C ... +125°C						
UL-rated ambient temperature		-20°C ... +80°C			-20°C ... +80°C							-20°C ... +80°C						
Output signal	<p><b>8252.XX.XXXX.XX.19</b></p>	<b>90</b>	<b>92</b>	<b>E1</b>	<b>E6</b>	<b>F4</b>	<b>F5</b>	<b>G2</b>	<b>G5</b>	<b>G8</b>				<b>F0</b>		<b>G3</b>		
		2	2	1	1	1	1	1	1	1	3	4	A	A	A	2	2	
		1	4	2	3	2	4	2	3	2/3	4	2	1	B	B	C	1	3
		4	3	4	4	4	2			4	4	5	E			3		
	<p><b>8252.XX.XXXX.XX.13/14/16/17/20/22/23/24/25/26/28/29</b></p>	<b>91</b>	<b>E3</b>	<b>E9</b>	<b>95</b>	<b>96</b>	<b>E2</b>	<b>F6</b>	<b>F7</b>	<b>G1</b>			<b>F3</b>	<b>F1</b>		<b>G4</b>		
		1	2	3	1	1	1	1	1	1	1	2	A	A	A	2	2	
		2	1	1	3	2	3	4	3	2	2	4	B	C	C	4	1	
		3	4	2	2	3	4	3	2	4	3	3	C/D	B/D	B	1	3	
		4	3	4	4	4	2	2	4	3	5	E	E		C	3		



<sup>1)</sup> Nur mit vorschriftsmässig montierter Kabeldose gültig

<sup>2)</sup> Entlüftung über Stecker/Kabel

<sup>3)</sup> IP68, 100 mbar, 4h

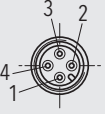
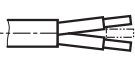
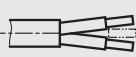
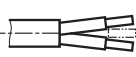
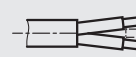
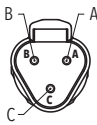
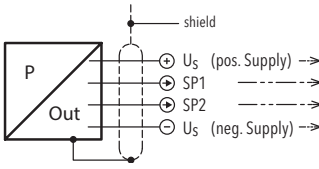
## Electrical connection

		Protection / electrical connection									
		IP67 <sup>1) 2)</sup>	IP67, IP68 <sup>2) 3)</sup>	IP67, IP68 <sup>2) 3)</sup>	IP67 <sup>2)</sup>	IP67, IP68 <sup>2) 3)</sup>	IP67, IP68 <sup>1) 4)</sup>				
		M12x1 4-pole <b>32</b> 	Cable <b>22</b> 	Cable <b>24</b> 	Cable <b>08</b> 	Cable <b>88</b> 	DT04-3P 3-pole <b>D3</b> 				
Ambient temperature		-40°C ... +125°C	-5°C ... +60°C	-40°C ... +70°C	-40°C ... +125°C	-40°C ... +100°C	-40°C ... +125°C				
UL-rated ambient temperature		-20°C ... +80°C	-5°C ... +60°C	-20°C ... +70°C	-20°C ... +80°C	-20°C ... +80°C	-20°C ... +80°C				
Output signal		<b>PS</b>	<b>T1</b>	<b>PS</b>	<b>T1</b>	<b>PS</b>	<b>T1</b>	<b>PS</b>	<b>T1</b>	<b>T1</b>	
	<b>8252.xx.XXXX.xx.PS/T1</b>	1 4 2 3	1 4 - 3	white green yellow brown	white green - brown	white green yellow brown	white green - brown	red white green black	red white - black	brown blue yellow / green black	brown blue - black

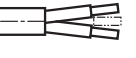
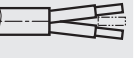
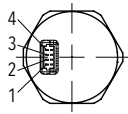
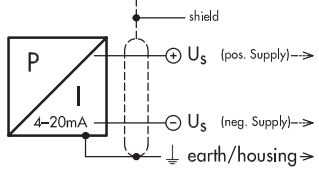
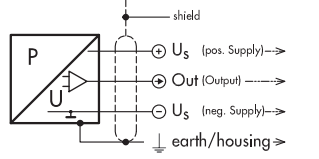
		Protection / electrical connection					
		IP67, IP68 <sup>2) 3)</sup>	IP67, IP68 <sup>2) 3)</sup>	IP67 <sup>2)</sup>	IP67, IP68 <sup>2) 3)</sup>	IP40	IP20
		Cable <b>22</b> 	Cable <b>24</b> 	Cable <b>08</b> 	Cable <b>88</b> 	Cable <b>A1</b> 	JST SH Series <b>J4</b> 
Ambient temperature		-5°C ... +60°C	-40°C ... +70°C	-40°C ... +125°C	-40°C ... +100°C	-5°C ... +60°C	-40°C ... +85°C
UL-rated ambient temperature		-5°C ... +60°C	-20°C ... +70°C	-20°C ... +80°C	-20°C ... +80°C	Not UL-listed	Not UL-listed
Output signal							
	<b>8252.xx.XXXX.xx.19</b>	white brown yellow	white brown yellow	red black green	brown black yellow / green	white brown yellow	white brown yellow
Output signal							
	<b>8252.xx.XXXX.xx.13/14/16/17/20/22/ 23/24/25/26/28/29</b>	white green brown yellow	white green brown yellow	red white black green	brown blue black yellow / green	white green brown yellow	white green brown yellow

<sup>1)</sup> Provided female electrical plug is mounted according to instructions

<sup>2)</sup> Ventilation via male electric plug/cable end

<sup>3)</sup> IP68, 20 bar, 30 min.

<sup>4)</sup> IP68, 100 mbar, 4h

4...20mA: min./max resistor vs. supply voltage @ Pmax = 100%

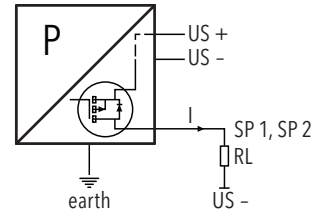
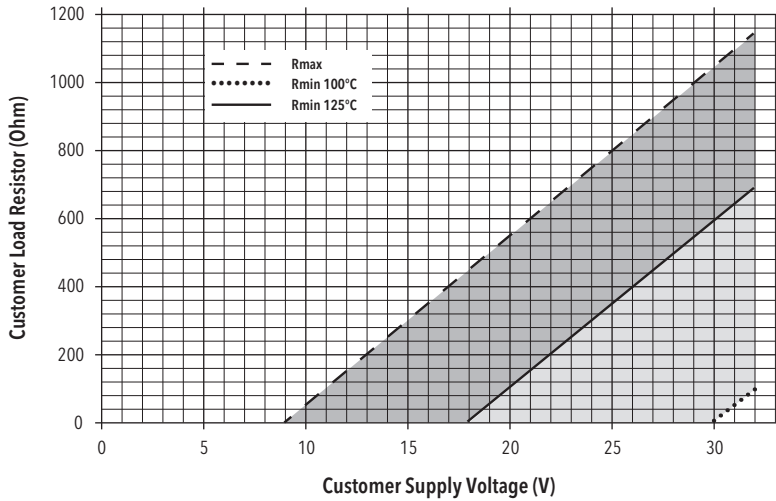

Connection of loads to switch contacts

## Functions switching output

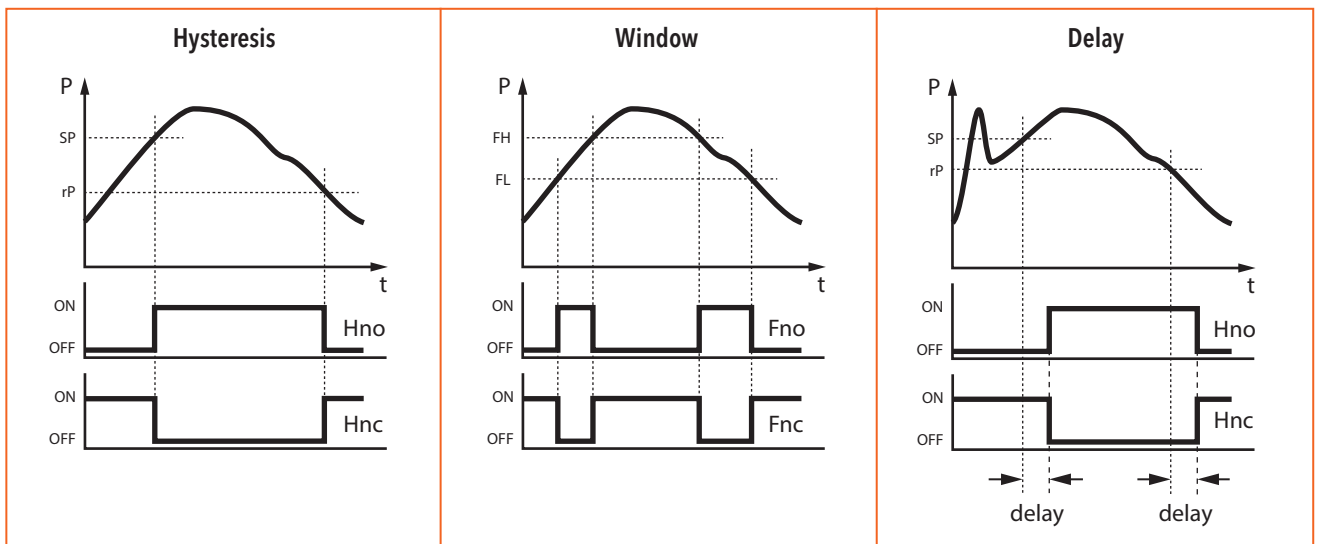

### Additional information

#### Documents

Data sheet	<a href="http://www.trafag.com/H72303">www.trafag.com/H72303</a>
Instructions	<a href="http://www.trafag.com/H73303">www.trafag.com/H73303</a>
Flyer	<a href="http://www.trafag.com/H70666">www.trafag.com/H70666</a>