

Technical specifications

Measuring principle:	Oscillating quartz measurement
Operating pressure:	max. 15 bar
Humidity:	suitable for outdoor usage: 55°C and max. 98% relative
Protection:	IP65
Vibration:	15 g (max. 6 mm), (5...2000 Hz)
Shock:	100g/ 6 ms
Torque moment pressure connection:	max. 25 Nm
Nominal temperature:	permanent: -40°C ... +70°C max. 200h per year: -55°C ... +70°C
Storage temperature:	-40°C ... +85°C
Media temperature:	-40°C ... +70°C

Electrical data

Digital output signal (PWM signal)

Density signal:	current pulses
	pulse frequency 10...292 Hz
Temperature signal:	Pulse width 2188...2565...2975µs (=Temp. -40...23...85°C)
Measuring range:	0...60 kg SF6/m ³
Supply voltage:	2-wire, 10...20 VDC 3-wire, 14...28 VDC
Ground:	via gas connection of sensor
Reaction time:	<10 ms (with density changes)

Analogue output signal

Density signal:	6.5...20 mA current loop
Measuring range:	0...56.1 kg SF6/m ³
Supply voltage:	2-wire, 10...32 VDC
Ground:	via gas connection of sensor
Reaction time:	<10 ms (with density changes)
Dielectrical strength:	250 VAC, 50 Hz
Resistance of insulation:	>10 MΩ, 250 VDC

Mechanical data

Material:	
Pressure connection:	1.4435 (AISI316L)
Tube	1.4301
O-Ring:	EPDM
Male electrical plug:	see ordering info
Screwed cable gland:	brass nickel plated
Mounting:	any position
Weight:	approx. 200...400 g

Type label (Identification)

For all inquiries please indicate:	
Instrument type:	Type: 8774.XX.XXXX.XX
Instrument serial number:	S/N: XXXXXX.X.XX.XX-XX

Dimensions / electrical connection

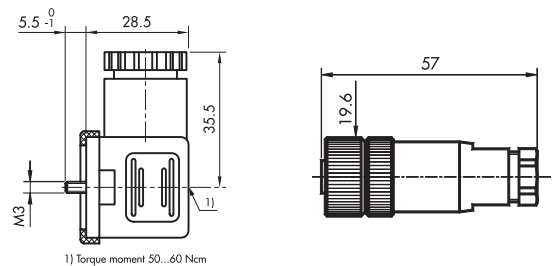
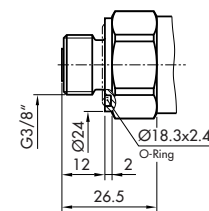
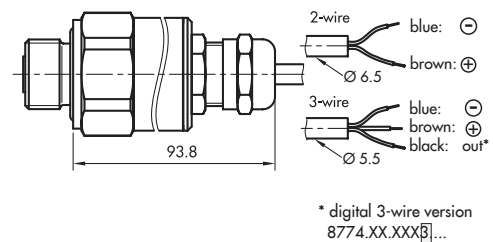
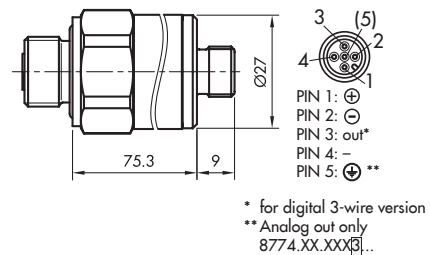
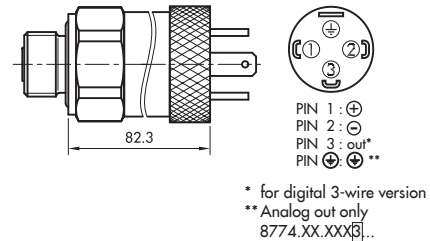

Initial response time after installation

t98 = Time scale for very first installation, measured value within 98% of exact value

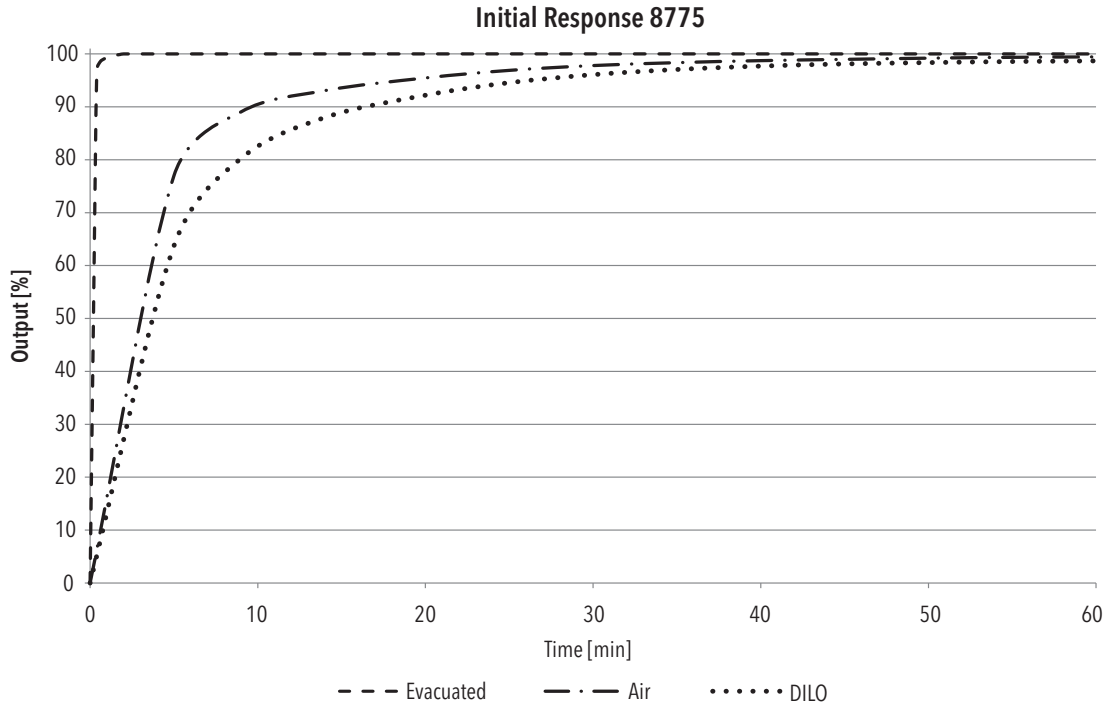

Air = device directly plugged under air, t98 = 17 min
 Evacuated = device directly plugged under vacuum, t98 = 5 sec
 DILO = with DILO DN7 plugged under air, t98 = 40 min

Electric schematic diagram for signal analysis

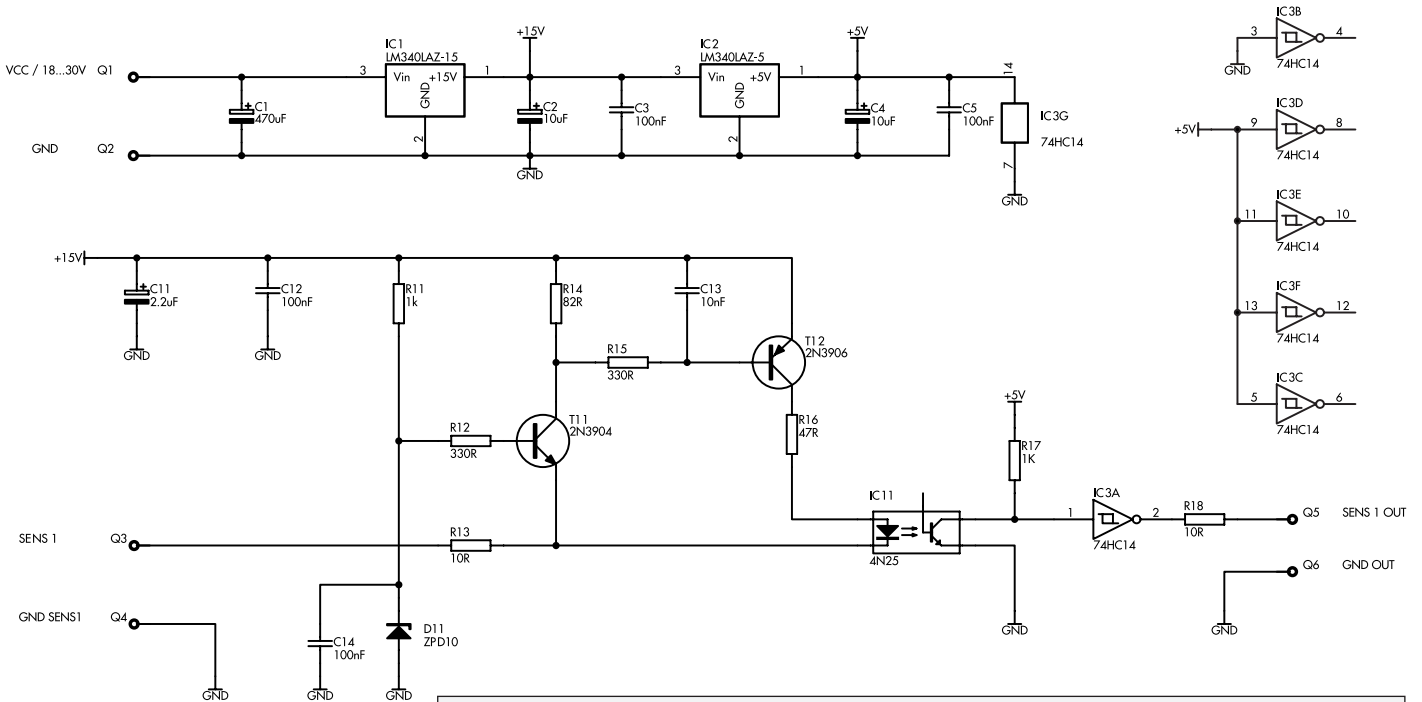

It is recommended to use a constant voltage source to measure the current consumption of the sensor

Functional diagram

Digital 2- or 3 wire

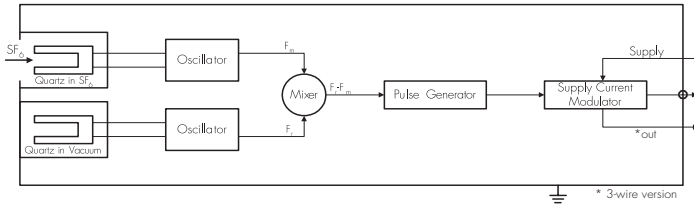

Analogue 2-wire

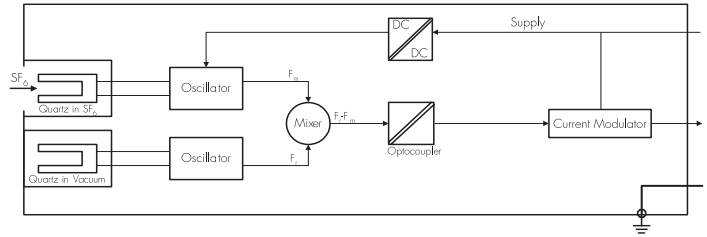

Digital output signal

Conversion frequency to SF6 gas density

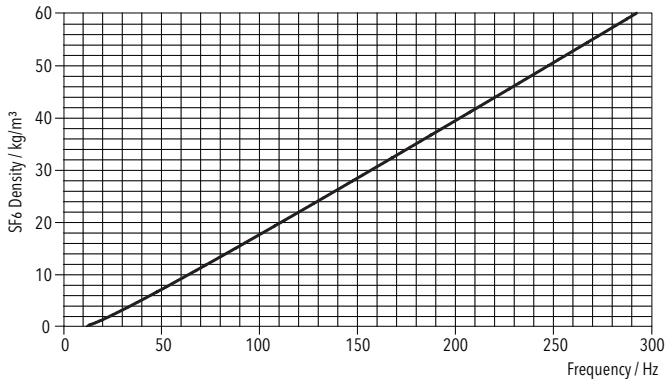

$$\text{Density } \rho = \left\{ \sqrt{(0,237 * F[\text{Hz}]) - 2,182 - 0,44} \right\}^2$$

Conversion frequency to SF6 gas density / pressure @ 20°C

Characteristic line SF6 pressure @ 20°C - Frequency

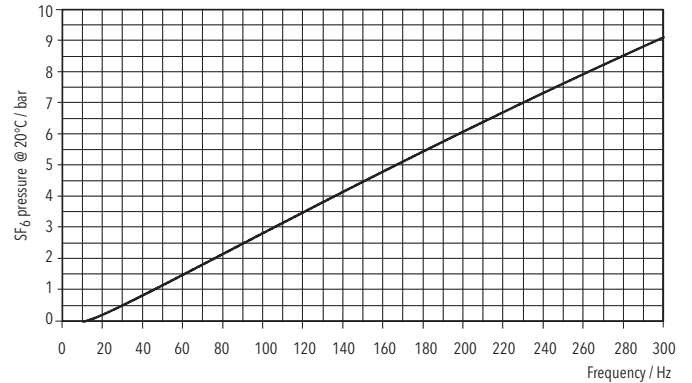

$$\text{SF}_6 \text{ Pressure [bar] @ 20°C} \approx 0.032 * F[\text{Hz}] - 0.32$$

(linearized approximation with additional error of ± 0.3 FS within 100...250 Hz)

Conversion frequency to SF6 gas density / pressure @ 20°C

Characteristic line SF6 pressure @ 20°C - Frequency

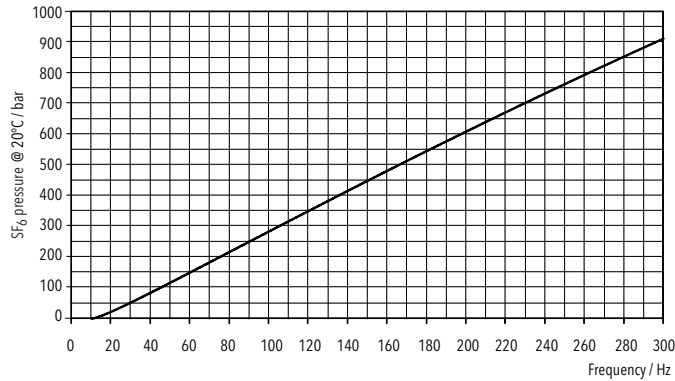

$$\text{SF}_6 \text{ Pressure [kPa] @ 20°C} \approx 3.2 * F[\text{Hz}] - 32$$

(linearized approximation with additional error of ± 0.3 FS within 100...250 Hz)

Conversion pulse width to temperature

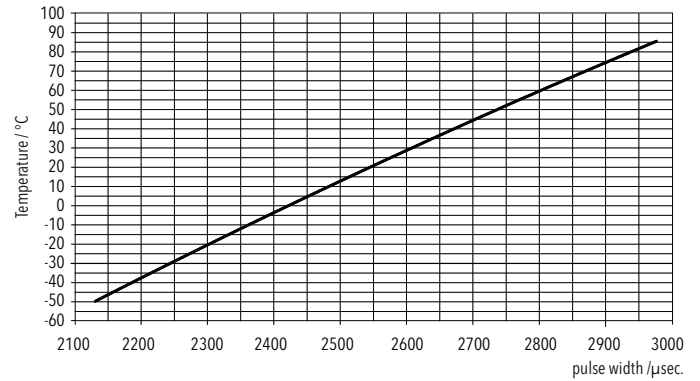

$$\text{Temp. } T = -1,951 * 10^{-5} * I[\mu\text{s}]^2 + 0,2595 * I[\mu\text{s}] - 514,3$$

PWM signal

current pulses, height typical 12-14 mA; power consumption electronics, without pulses typical 2 mA

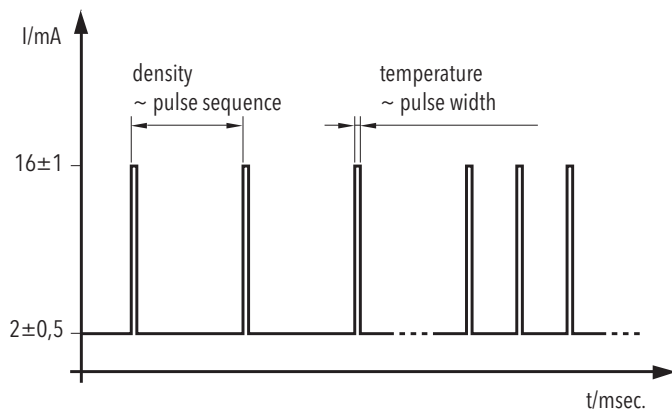

rise time (with Schmidt Trigger) < 50 nsec.

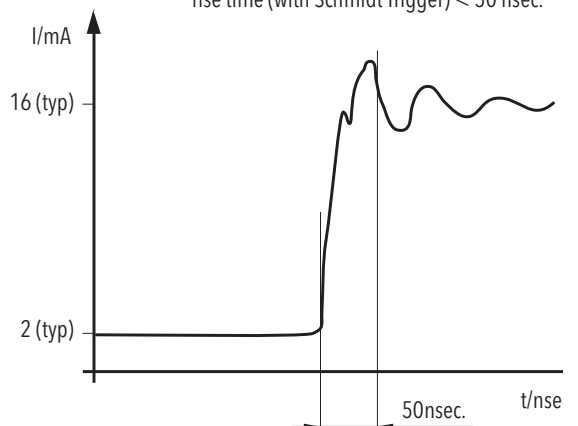

Analogue output signal

SF₆ gas density

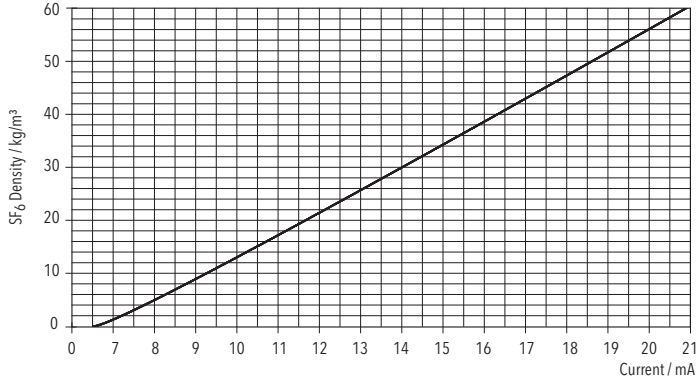

$$\text{Density } \rho = \{ \sqrt{4,651 * (I - 6,005) - 2,185 - 0,44} \}^2$$

SF₆ gas pressure @ 20°C

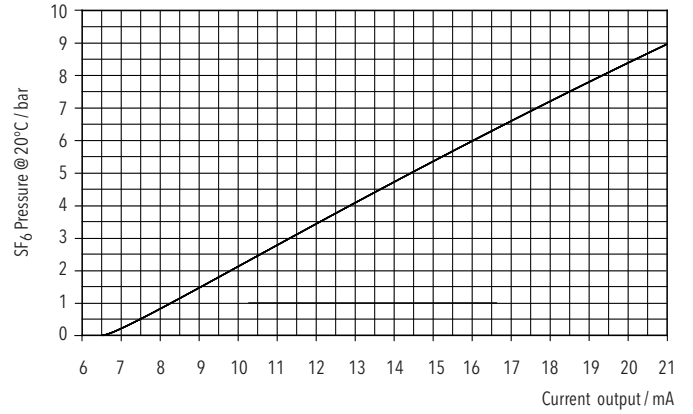

$$\begin{aligned} \text{Pressure } p @ 20^\circ\text{C} = & \{ 0,000569502 * T[\text{K}] * \text{Density} [\text{kg}/\text{m}^3] \\ & + (0,00250695 * 0,000569502 * T[\text{K}] - 0,00073822) * \text{Density} [\text{kg}/\text{m}^3]^2 \\ & - (0,00000212238 * 0,000569502 * T[\text{K}] - 0,000000513) * \text{Density} [\text{kg}/\text{m}^3]^3 \} \end{aligned}$$

$$\approx 0.6303 * \text{current} [\text{mA}] - 4.1419$$

(add. non-linearity ±0.3 FS between 9.5 and 19.25 mA)