



Sensor Master by Trafag AG

Technical specification

Ambient temperature: -25°C ... +85°C (housing and display)
 Media temperature: -50°C ... +150°C
 Protection: IP67
 Display unit: °C, °F, K, user scale
 Switching current: Max. 0.5 A per switching output
 Parametrisation: With 3 buttons and menu navigation or via NFC - Smartphone App

Type label description

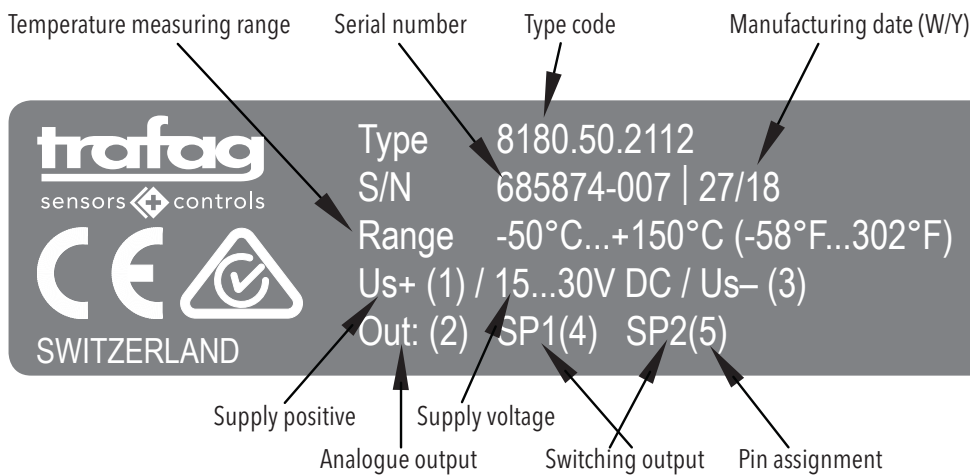

Electrical connection

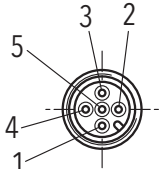
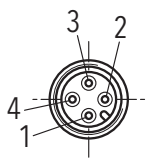
Ingress Protection	IP67*)	IP67*)
Designation	M12x1 5-pole	M12x1 4-pole
Type code	8180.XX.XXXX 35	8180.XX.XXXX 32
Pin configuration		

*) Provided female connector is mounted according to instructions

Output signal / supply voltage

Output	I _{SUPPLY}	U _{SUPPLY}
4 ... 20 mA	≤ 30 mA	15 ... 30 VDC
0 ... 10 VDC	≤ 30 mA	15 ... 30 VDC
0 ... 5 VDC	≤ 30 mA	15 ... 30 VDC
1 ... 6 VDC	≤ 30 mA	15 ... 30 VDC

Connection of the measuring equipment

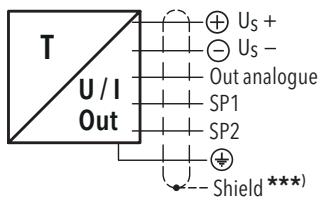

***) The use of a shielded cable is recommended

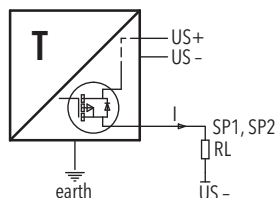

Connection of loads to switching output

4...20mA: min./max resistor vs. supply voltage @ Pmax = 100%

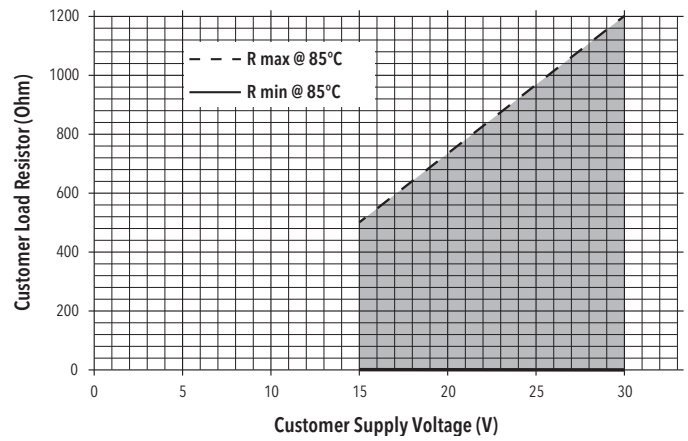

Mounting

Tighten the device

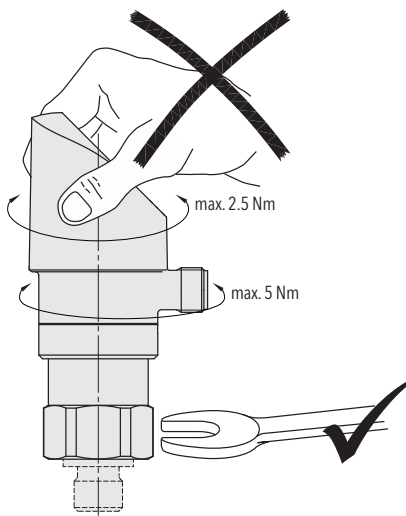

Compression fitting

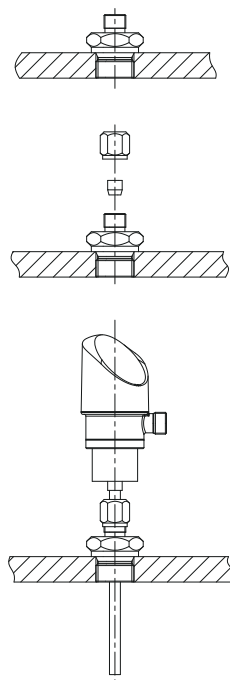

Display indication

	Description
OL	The measured temperature is >3% above the measuring range end-point → The indication disappears as soon as the pressure is reduced again
UL	The measured temperature is >3% below the measuring range zero-point → The indication disappears as soon as the pressure is reduced again
FALS	Incorrect access code → Enter the correct access code
Sbrk	Sensor break; the sensor element is defective → Please replace the temperature measuring device
Fi2c	Internal device communication is interrupted → Please replace the temperature measuring device
Ecrc	Internal memory damage occurred → Execute a factory reset. If the recovery is not successful, replace the temperature measuring device
FE2P	Internal memory damage occurred → Execute a factory reset. If the recovery is not successful, replace the temperature measuring device
EnFc	NFC communication was not successful → Try again to communicate again. If the error persists, replace the temperature measuring device
E.OFC	Zero-set out of range The measured pressure value is outside of the valid range for the zero-set function. → Press [Enter] ↵ on the measuring device to reset the error indication. This error indication does not appear when performing the zero-set function by means of the Sensor Master App (Android smartphone)

Switching output functions

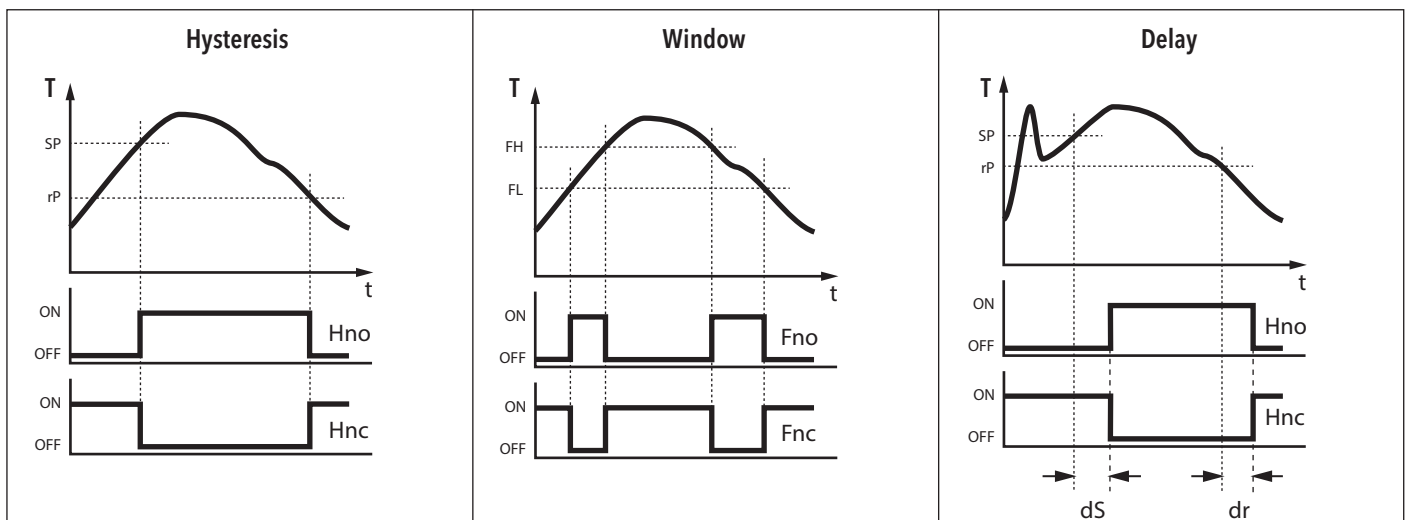

Dimensions

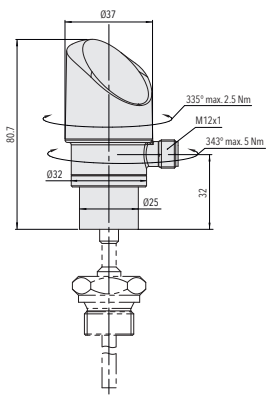

8180.XX.XXXX.35/32.XX.XX.XX

Protective cap

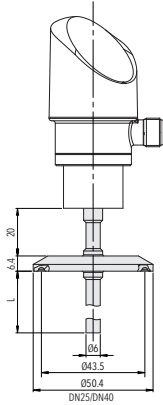
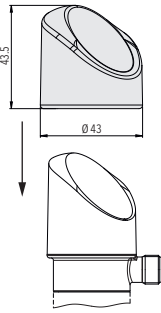

8180.XX.XXXX.1G/2G/3G/4G/5G...

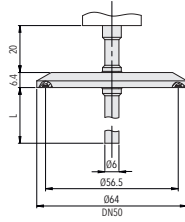

8180.XX.XXXX.1J/2J/3J/4J/5J...

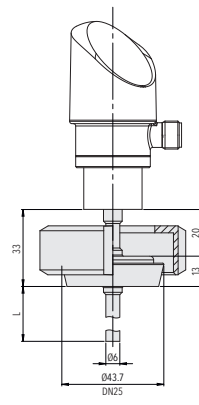

8180.XX.XXXX.1L/2L/3L/4L/5L...

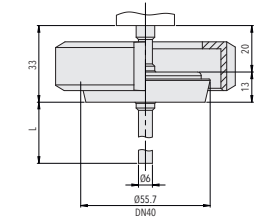

8180.XX.XXXX.1M/2M/3M/4M/5M...

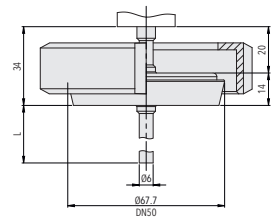

8180.XX.XXXX.1N/2N/3N/4N/5N...

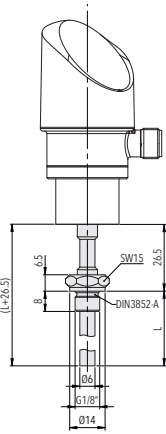

8180.XX.XXXX.11/21/31/41/51...

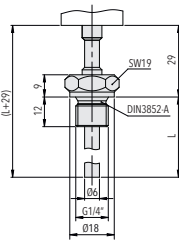

8180.XX.XXXX.12/22/32/42/52...

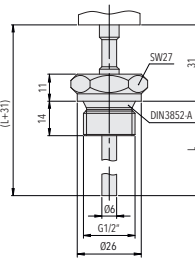

8180.XX.XXXX.13/23/33/43/53...

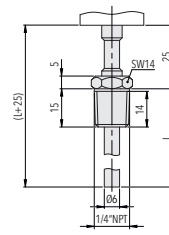

8180.XX.XXXX.1B/2B/3B/4B/5B...

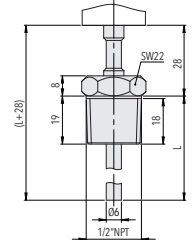

8180.XX.XXXX.1C/2C/3C/4C/5C...

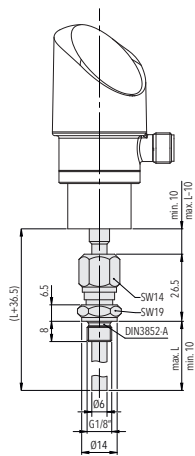

8180.XX.XXXX.14/24/34/44/54...

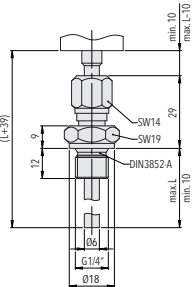

8180.XX.XXXX.15/25/35/45/55...

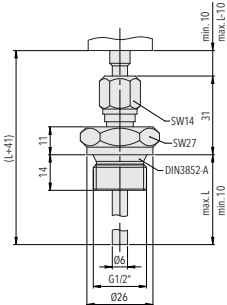

8180.XX.XXXX.16/26/36/46/56...

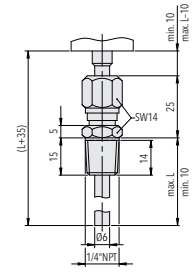

8180.XX.XXXX.1D/2D/3D/4D/5D...

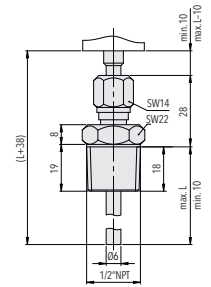

8180.XX.XXXX.1E/2E/3E/4E/5E...

Operating menu

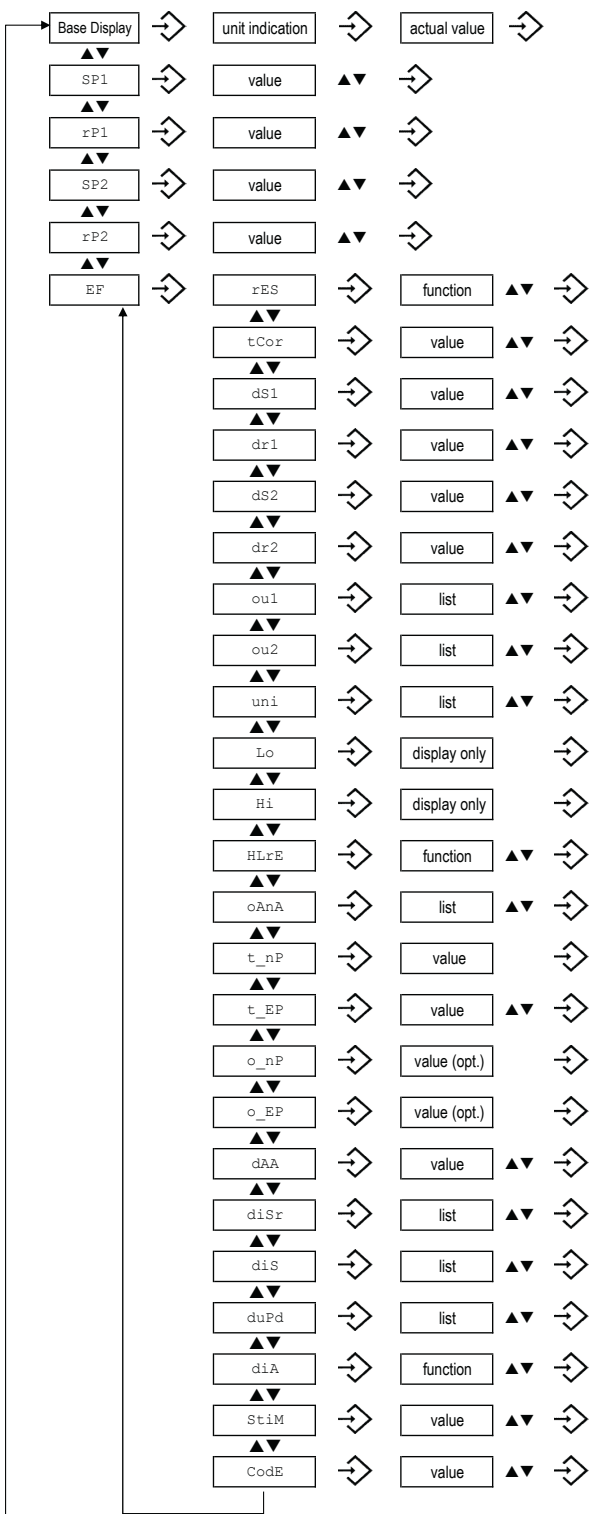

Description	Value range
Switch point SP1 (Hysteresis) or Window high FH1	SP1 > rP1, FH1 > FL1 Hysteresis ≥ 1 % FS
Reset point rP1 (Hysteresis) or Window low FL1	rP1 < SP1, FL1 < FH1 Hysteresis ≥ 1 % FS
Switch point SP2 (Hysteresis) or Window high FH2	SP2 > rP2, FH2 > FL2 Hysteresis ≥ 1 % FS
Reset point rP2 (Hysteresis) or Window low FL2	rP2 < SP2, FL2 < FH2 Hysteresis ≥ 1 % FS
Reset to factory settings	
Temperature offset correction	± 5 °C
Switching delay time for SP1/FH1	0.01 ... 99.99s
Switching delay time for rP1/FL1	0.01 ... 99.99s
Switching delay time for SP2/FH2	0.01 ... 99.99s
Switching delay time for rP2/FL2	0.01 ... 99.99s
Function switching output 1	Hysteresis NO (Hno), Hysteresis NC (Hnc) Window NO (Fno), Window NC (Fnc)
Function switching output 2	Hysteresis NO (Hno), Hysteresis NC (Hnc) Window NO (Fno), Window NC (Fnc)
Temperature unit	°C, °F, K, user scale (optional)
Lowest measured temperature	
Highest measured temperature	
Reset highest and lowest temperature value	
Analogue output type	I, U, off
Temperature zero point	0 % ... 50 % FS
Temperature end point	50 % ... 100 % FS
Analogue output zero point	(optionally adaptable)
Analogue output end point	(optionally adaptable)
Damping analogue output rise time 10 ... 90 % nominal temperature	0.01 ... 3.00 s
Display rotate	no, yes (180°)
Display mode	actual, highest, lowest, off, act. - 1 decimal, act. - 2 dec., act. - 3 dec.
Display update rate	1, 2, 5, 20 Hz
Diagnostic mode	
Sampling time for logger	0.1 ... 999.9 s, off (0)
Access code	4-digit code

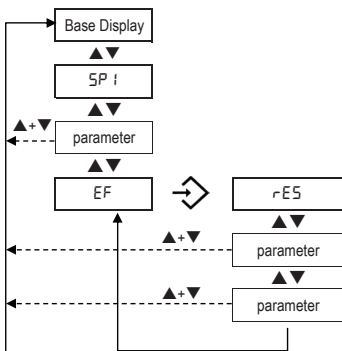

By pressing ▲+▼ simultaneously the menu will return to the base display or automatically after ca. 60 s without operation.

pw* When performing a parameter change by pressing ▲ or ▼ and if an access code has been defined, it has to be entered digit by digit.

After confirming the new parameter value, the menu item of the changed parameter will be displayed.